

# Owner's Manual

Please read before using this unit.

## DVD/CD Player with Video Cassette Recorder DV220SL8 A

# SYLVANIA

INSTRUCCIONES EN  
ESPAÑOL INCLUIDAS.

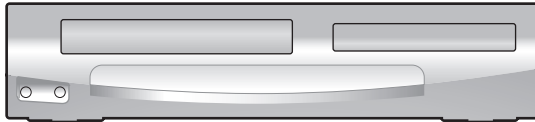

If you need additional operating assistance after reading this owner's manual, please call  
**TOLL FREE : 1-800-968-3429**  
or visit our web site at  
<http://www.sylvaniaconsumerelectronics.com>

### Supplied Accessories

remote control unit  
(NB606UD / NB656UD)



RCA audio/video cables  
(WPZ0102TM018 / WPZ0102LTE01)

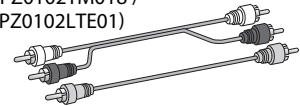

batteries  
(AA x 2)



owner's manual  
(1VMN28434)

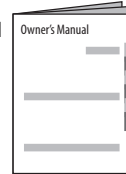

### Contents

#### PRECAUTIONS

<b>Safety Instructions</b> .....	<b>2</b>
Symbols Used in This Manual.....	4
Maintenance.....	4
<b>About Cassette Tapes and Discs</b> .....	<b>5</b>
Playable Media.....	5
Unplayable Discs.....	5

#### SETUP

<b>Connections</b> .....	<b>6</b>
Connection to a TV.....	6
Connection to an Audio System.....	7
Connection to a Cable/Satellite Box.....	7
<b>Preparation for Use</b> .....	<b>8</b>
Turning on Unit for the First Time.....	8
Clock Setting.....	8
<b>Function Overview</b> .....	<b>9</b>
Front Panel Indicator Lights.....	9
Selecting DVD or VCR Operation.....	9
Front & Rear Terminals.....	9
Remote Control.....	10
Installing the Batteries for the Remote Control.....	10

#### VCR FUNCTIONS

<b>Playback</b> .....	<b>11</b>
<b>Other Operations</b> .....	<b>11</b>
Index Search.....	11
Time Search.....	11
Auto Repeat.....	12
<b>Recording</b> .....	<b>12</b>
Recording & One-touch Timer Recording (OTR).....	12
Timer Recording.....	12
Notes for Timer Recording & One-touch Timer Recording (OTR).....	13
Satellite Link.....	14
Copying a Cassette Tape.....	14

#### DVD FUNCTIONS

<b>Playback</b> .....	<b>15</b>
<b>MP3 Playback</b> .....	<b>16</b>
<b>On-Screen Display</b> .....	<b>16</b>
<b>Search Functions</b> .....	<b>17</b>
Using Track Search.....	17
Using Title / Chapter Search.....	17
Using Time Search.....	17
Marker Setting.....	17
<b>Repeat / Random / Programmed Playback</b> .....	<b>18</b>
Repeat Playback.....	18
Repeat A-B Playback.....	18
Random Playback.....	18
Programmed Playback.....	18
<b>Special Settings</b> .....	<b>19</b>
Subtitle Language.....	19
Audio Language.....	19
Camera Angles.....	19
Black Level Setting.....	19
Stereo Sound Mode.....	19
Virtual Surround.....	19
<b>DVD Setting</b> .....	<b>20</b>
LANGUAGE Setting.....	20
DISPLAY Setting.....	21
AUDIO Setting.....	21
PARENTAL Setting.....	22
OTHERS Setting.....	22
Reset to the Default Setting (Except for PARENTAL Setting).....	23

#### INFORMATION

<b>Troubleshooting Guide</b> .....	<b>23</b>
<b>Specifications</b> .....	<b>24</b>
<b>Language Code List</b> .....	<b>24</b>
<b>LIMITED WARRANTY</b> .....	<b>24</b>
<b>Español</b> .....	<b>25</b>
<b>Quick Use Guide</b> .....	<b>27</b>

### Basic TV Connection

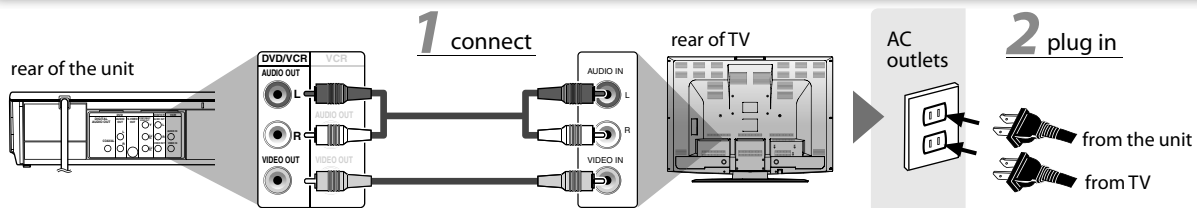

© 2009 Funai Electric Co., Ltd.

PRECAUTIONS

SETUP

INFORMATION DVD FUNCTIONS VCR FUNCTIONS

Español



## PRECAUTIONS

### Safety Instructions

The model and serial numbers of this unit may be found on the cabinet.  
You should record and retain those numbers for future reference.

Model No.: \_\_\_\_\_

Serial No.: \_\_\_\_\_

**WARNING:** TO REDUCE THE RISK OF FIRE OR ELECTRIC SHOCK, DO NOT EXPOSE THIS APPARATUS TO RAIN OR MOISTURE. APPARATUS SHALL NOT BE EXPOSED TO DRIPPING OR SPLASHING AND NO OBJECTS FILLED WITH LIQUIDS, SUCH AS VASES, SHALL BE PLACED ON THE APPARATUS.



**CAUTION**  
**RISK OF ELECTRIC SHOCK**  
**DO NOT OPEN**



**CAUTION:** TO REDUCE THE RISK OF ELECTRIC SHOCK, DO NOT REMOVE COVER (OR BACK). NO USER SERVICEABLE PARTS INSIDE. REFER SERVICING TO QUALIFIED SERVICE PERSONNEL.



The lightning flash with arrowhead symbol, within an equilateral triangle, is intended to alert the user to the presence of uninsulated "dangerous voltage" within the product's enclosure that may be of sufficient magnitude to constitute a risk of electric shock to persons.



The exclamation point within an equilateral triangle is intended to alert the user to the presence of important operating and maintenance (servicing) instructions in the literature accompanying the appliance.

The important note is located on the rear or bottom of the cabinet.

## IMPORTANT SAFETY INSTRUCTIONS

1. Read these instructions.
2. Keep these instructions.
3. Heed all warnings.
4. Follow all instructions.
5. Do not use this apparatus near water.
6. Clean only with dry cloth.
7. Do not block any ventilation openings. Install in accordance with the manufacturer's instructions.
8. Do not install near any heat sources such as radiators, heat registers, stoves, or other apparatus (including amplifiers) that produce heat.
9. Do not defeat the safety purpose of the polarized or grounding-type plug. A polarized plug has two blades with one wider than the other. A grounding type plug has two blades and a third grounding prong. The wide blade or the third prong are provided for your safety. If the provided plug does not fit into your outlet, consult an electrician for replacement of the obsolete outlet.
10. Protect the power cord from being walked on or pinched particularly at plugs, convenience receptacles, and the point where they exit from the apparatus.
11. Only use attachments/accessories specified by the manufacturer.
12. Use only with the cart, stand, tripod, bracket, or table specified by the manufacturer, or sold with the apparatus. When a cart is used, use caution when moving the cart/apparatus combination to avoid injury from tip-over.
13. Unplug this apparatus during lightning storms or when unused for long periods of time.
14. Refer all servicing to qualified service personnel. Servicing is required when the apparatus has been damaged in any way, such as power-supply cord or plug is damaged, liquid has been spilled or objects have fallen into the apparatus, the apparatus has been exposed to rain or moisture, does not operate normally, or has been dropped.



### FCC WARNING

This equipment may generate or use radio frequency energy. Changes or modifications to this equipment may cause harmful interference unless the modifications are expressly approved in the manual. The user could lose the authority to operate this equipment if an unauthorized change or modification is made.

### RADIO-TV INTERFERENCE

This equipment has been tested and found to comply with the limits for a Class B digital device, pursuant to Part 15 of the FCC Rules. These limits are designed to provide reasonable protection against harmful interference in a residential installation. This equipment generates, uses, and can radiate radio frequency energy and, if not installed and used in accordance with the instructions, may cause harmful interference to radio communications. However, there is no guarantee that interference will not occur in a particular installation. If this equipment does cause harmful interference to radio or television reception, which can be determined by turning the equipment off and on, the user is encouraged to try to correct the interference by one or more of the following measures:

- 1) Reorient or relocate the receiving antenna.
- 2) Increase the separation between the equipment and receiver.
- 3) Connect the equipment into an outlet on a circuit different from that to which the receiver is connected.
- 4) Consult the dealer or an experienced radio/TV technician for help.

**This Class B digital apparatus complies with Canadian ICES-003.**

**Cet appareil numérique de la classe B est conforme à la norme NMB-003 du Canada.**

Disconnect the mains plug to shut off when find trouble or not in use. The mains plug shall remain readily operable.





**CAUTION:** Danger of explosion if battery is incorrectly replaced. Replace only with the same or equivalent type.  
**WARNING:** Batteries (Battery pack or battery installed) shall not be exposed to excessive heat such as sunshine, fire, or the like.

**LASER SAFETY**

This apparatus employs a laser. Only a qualified service person should remove the cover or attempt to service this apparatus, due to possible eye injury.

**CAUTION:** Use of controls or adjustments or performance of procedures other than those specified herein may result in hazardous radiation exposure.

**CAUTION:** Visible and invisible laser radiation when open and interlocks defeated. Do not stare into beam.

**LOCATION:** Inside, near the deck mechanism.

**IMPORTANT COPYRIGHT INFORMATION**

Unauthorized copying, broadcasting, public performance and lending of discs are prohibited. This product incorporates copyright protection technology that is protected by U.S. patents and other intellectual property rights. Use of this copyright protection technology must be authorized by Macrovision, and is intended for home and other limited viewing uses only unless otherwise authorized by Macrovision. Reverse engineering or disassembly is prohibited.

Do not place the unit on the furniture that is capable of being tilted by a child and an adult leaning, pulling, standing or climbing on it. A falling unit can cause serious injury or even death.

**To Avoid the Hazards of Electrical Shock and Fire**

- Do not handle the power cord with wet hands.
- Do not pull on the power cord when disconnecting it from an AC outlet. Grasp it by the plug.
- Do not put your fingers or objects into the unit.

**Location and Handling**

- Do not install the unit in direct sunlight, near strong magnetic fields, or in a place subject to dust or strong vibration.
- Avoid a place with drastic temperature changes.
- Install the unit in a horizontal and stable position. Do not place anything directly on top or bottom of the unit. Depending on your external devices, noise or disturbance of the picture and/or sound may be generated if the unit is placed too close to them. In this case, please ensure enough space between the external devices and the unit.
- Depending on the environment, the temperature of this unit may increase slightly. This is not a malfunction.
- Be sure to remove the disc and unplug the AC power cord from the outlet before carrying the unit.

**Dew Condensation Warning**

- Dew condensation may form inside the unit in the following conditions. If so, do not use this unit at least for a few hours until its inside gets dry.
  - The unit is moved from a cold place to a warm place.
  - Under conditions of high humidity.
  - After heating a cold room.

**Note about Recycling**

- This unit's packaging materials are recyclable and can be reused. Please dispose of any materials in accordance with your local recycling regulations.
- Batteries should never be thrown away or incinerated but disposed of in accordance with your local regulations concerning chemical wastes.



**Notice for Progressive Scan Output**

- Consumers should note that not all high definition television sets are fully compatible with this product and may cause artifacts to be displayed in the picture. In case of picture problems with 525(480) progressive scan output, it is recommended that the user switch the connection to the 'standard definition' output. If there are questions regarding your TV set compatibility with this 525p(480p) DVD player, please contact our customer service center.







**Note to CATV system installer:**

- This reminder is provided to call the CATV system installer's attention to Article 820-40 of the NEC that provides guidelines for proper grounding and, in particular, specifies that the cable ground should be connected to the grounding system of the building, as close to the point of cable entry as practical.

**Symbols Used in This Manual**

The following symbols appear in some headings in this manual.

-  : Description refers to video cassette tapes.
-  : Description refers to DVD-video.
-  : Description refers to audio CD.
-  : Description refers to CD-RW/-R with MP3 files.

**Maintenance**

**Servicing**

- Please refer to relevant topics on the "Troubleshooting Guide" on page 23 before returning the product.
- If this unit becomes inoperative, do not try to correct the problem by yourself. There are no user-serviceable parts inside. Turn off, unplug the power plug, and please call our toll free customer support line found on the cover of this manual to locate an authorized service center.

**Cleaning the Cabinet**

- Wipe the front panel and other exterior surfaces of the unit with a soft cloth.
- Never use a solvent, thinner, benzene or alcohol to clean the unit. Do not spray insecticide liquid near the unit. Such chemicals may discolor the surface or damage the unit.

**Cleaning Discs**

- When a disc becomes dirty, clean it with a cleaning cloth. Wipe the disc from the center to out. Do not wipe in a circular motion.
- Do not use solvents such as benzine, thinner, commercially available cleaners, detergent, abrasive cleaning agents or antistatic spray intended for analog records.

**Cleaning the Disc Lens**

- If this unit continues to perform improperly even after you have referred to the relevant sections and to the "Troubleshooting Guide" in this manual, the laser optical pickup unit may be dirty. Consult your dealer or an authorized service center for inspection and cleaning of the laser optical pickup unit.

**Disc Handling**

- When you handle a disc, hold it by its edge and try not to touch the surface of the disc.
- Always store the disc in its protective case when not in use.

**Auto Head Cleaning**

- Automatically cleans video heads as you insert or remove a cassette tape, so you can see a clear picture.
- Playback picture may become blurred or interrupted while the TV program reception is clear. Dirt accumulated on the video heads after a long period of use, or the usage of rental or worn cassette tapes can cause this problem. If a streaky or snowy picture appears during playback, the video heads in your unit may need to be cleaned.
  1. Please visit your local audio/video store and purchase a good quality VHS video head cleaner.
  2. If a Video head cleaner does not solve the problem, please call our toll free customer support line found on the cover of this manual to locate an authorized service center.

**Note:**

- Remember to read the instructions along with the video head cleaner before use.
- Clean video heads only when problems occur.

© 2009 Funai Electric Co., Ltd.

All rights reserved. No part of this manual may be reproduced, copied, transmitted, disseminated, transcribed, downloaded or stored in any storage medium, in any form or for any purpose without the express prior written consent of Funai. Furthermore, any unauthorized commercial distribution of this manual or any revision hereto is strictly prohibited.

Information in this document is subject to change without notice. Funai reserves the right to change the content herein without the obligation to notify any person or organization of such changes.

**FUNAI** with the  design is a registered trademark of Funai Electric Co., Ltd and may not be used in any way without the express written consent of Funai. All other trademarks used herein remain the exclusive property of their respective owners. Nothing contained in this manual should be construed as granting, by implication or otherwise, any license or right to use any of the trademarks displayed herein. Misuse of any trademarks or any other content in this manual is strictly prohibited. Funai shall aggressively enforce its intellectual property rights to the fullest extent of the law.

SYLVANIA is a registered trademark of OSRAM SYLVANIA Inc., used under license.



Manufactured under license from Dolby Laboratories. "Dolby" and the double-D symbol are trademarks of Dolby Laboratories.



# About Cassette Tapes and Discs

## Playable Media

Type of media	Mark (logo)	Region code	Recorded signals	Media size	Tape speed and disc types
cassette tape		—	analog video	tape width 1/2 inches (12.65 mm)	SP: 1-5/16 inch/sec. (33.40 mm/sec.) SLP: 7/16 inch/sec. (11.12 mm/sec.)
DVD-video *1, 2, 3, 5, 9		or	digital video (MPEG2)	5 inches (12 cm) or 3 inches (8 cm)	 e.g.) title 1   title 2 chapter 1   chapter 2   chapter 3   chapter 4   chapter 1   chapter 2
DVD-RW DVD-R *1, 3, 4, 5, 6, 8, 9, 10	 	—			
DVD+RW DVD+R *1, 3, 4, 5, 7, 8, 9, 10	 	—			
audio CD *3, 5, 9		—	digital audio or MP3	5 inches (12 cm) or 3 inches (8 cm)	 audio CD e.g.) track 1   track 2   track 3   track 4   track 5   track 6   MP3 e.g.) folder 1   folder 2 file 1   file 2   file 3   file 4   file 5   file 6
CD-RW CD-R *3, 4, 5, 8, 9	   	—			

PRECAUTIONS

**DVD** is a trademark of DVD Format/Logo Licensing Corporation.

**If you cannot play back a disc which bears one of the marks above, check the following.**

- \*1: This unit conforms to the NTSC color system. Discs recorded in other color systems such as PAL cannot be played back.
- \*2: Certain DVD-video does not operate as described in this manual due to the intentions of the disc's producers.
- \*3: Scratched or stained discs may not be played back.
- \*4: Some discs cannot be played back because of incompatible recording conditions, characteristics of the recorder or special properties of discs.
- \*5: You can play back discs which bear the marks above. If you use nonstandardized discs, this unit may not play them back. Even if they are played back, the sound or video quality will be compromised.
- \*6: You may play back the unfinalized DVD-RW/-R recorded in the video format on our brand's DVD recorder. However, depending on the recording status of a disc, the disc may not be played back at all or normally (the picture or sound may not be smooth, etc.). In this case, you need to finalize the disc with the DVD recorder. Refer to the manual accompanying the DVD recorder.
- \*7: Only discs recorded in the video format and finalized can be played back.  
Unfinalized discs cannot be played back. Depending on the recording status of a disc, the disc may not be played back at all (the picture or sound may not be smooth, etc.).
- \*8: If the recorded portion of the disc is too small (less than 2-3/16 inches (55 mm) across), it may not play back properly.
- \*9: Do not glue paper or put stickers on to the disc. These may damage the disc, and the unit may not read it correctly.
- \*10: Discs recorded in the VR (video recording) format cannot be played back.

## Unplayable Discs

**NEVER play the following discs as malfunction may result!**

DVD-RAM, DVD-audio, CD-i, photo CD, video CD, DVD with region codes other than 1 or ALL, DTS-CD, DVD-ROM for personal computers, CD-ROM for personal computers

**On the following disc, the sound MAY NOT be heard.**

super audio CD

### Note:

- Only the sound recorded on the normal CD layer can be delivered. The sound recorded on the high density super audio CD layer cannot be delivered.

**Any other discs without compatibility indications**



# SETUP

## Connections

### Connection to a TV

Please refer to "Basic TV Connection" on the front page before you use this unit.

#### VCR and Basic DVD Connection

#### Available for DVD only

#### DVD's picture quality

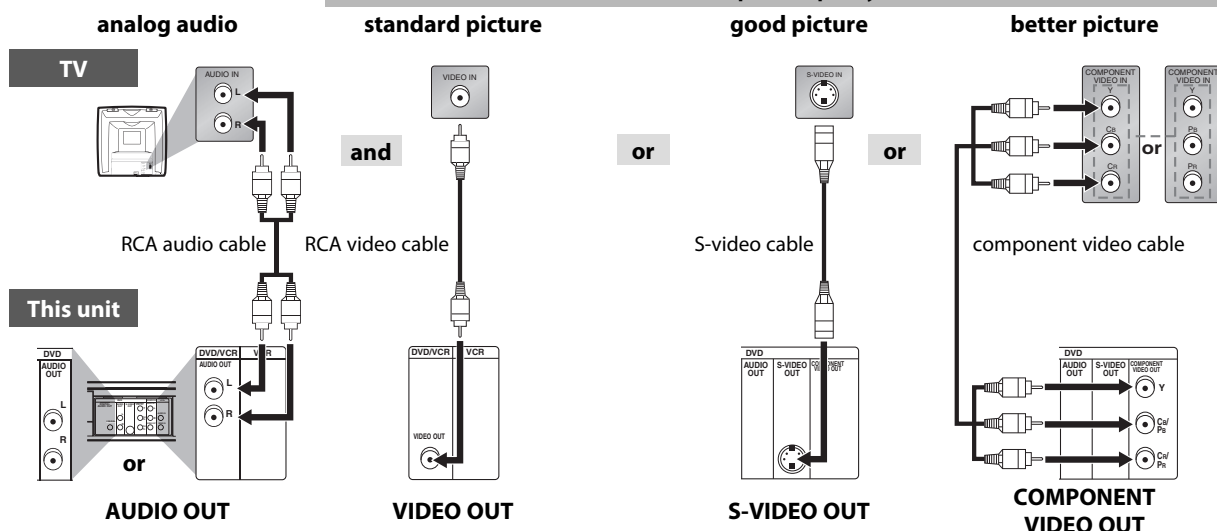

#### Supplied cables used in this connection are as follows:

- RCA audio cable (L/R) x 1
  - RCA video cable x 1
- Please purchase the rest of the necessary cables at your local store.

#### Note:

- Connect this unit directly to your TV. If an RCA audio/video cables are connected to a VCR, pictures may be distorted due to the copy protection system.
- DIGITAL AUDIO OUT (COAXIAL), DVD AUDIO OUT, S-VIDEO OUT and COMPONENT VIDEO OUT jacks are only useful in DVD mode.

#### If your TV is compatible with 525 (480) progressive scanning, and you want to enjoy that high quality picture for DVD playing:

You must select the connection COMPONENT VIDEO OUT above and progressive scanning mode. To set the mode, set "PROGRESSIVE" to "ON" in "DISPLAY" menu, so that the PROGRESSIVE SCAN indicator on this unit lights up. Refer to pages 20-21 for more details.

- When "PROGRESSIVE" is "ON", video signals from the unit's VIDEO OUT and S-VIDEO OUT jacks will be distorted or not be output at all for DVD playing. The picture will be OK for VCR use from the VIDEO OUT jack.

#### If your TV is not compatible with progressive scanning:

Use this unit in interlace mode and set "PROGRESSIVE" to "OFF" either in "DISPLAY" menu or by pressing and holding [PLAY ►] on the front of the unit on the DVD side for more than 5 seconds, so that the PROGRESSIVE SCAN indicator on this unit turns off.

#### After connecting to your TV:

You will need to switch to video input on your TV. This is usually marked TV/VIDEO, INPUT or AUX. Please refer to your TV's owner's manual for details.

#### Input modes for common TV brands:

Listed below are inputs for common brand name TV's.

Admiral:	AUX	Panasonic:	TV/VIDEO
Curtis Mathis:	LINE1, LINE2, 00, 90, 91, 92, 93	RCA:	INPUT, TV/VCR, 00, 90, 91, 92, 93
GE:	INPUT, TV/VCR, 00, 90, 91, 92, 93	Samsung:	TV/VIDEO
Hitachi:	INPUT, AUX	Sanyo:	VIDEO
JVC:	VIDEO, VIDEO1, VIDEO2, VIDEO3	Sharp:	00
Kenwood:	AUX	Sony:	VIDEO1, VIDEO2, VIDEO3
LXI-Series:	00	Toshiba:	TV/GAME
Magnavox:	AUX CHANNEL	Zenith:	00

## Connection to an Audio System

### Playing 2 Channel Analog Audio

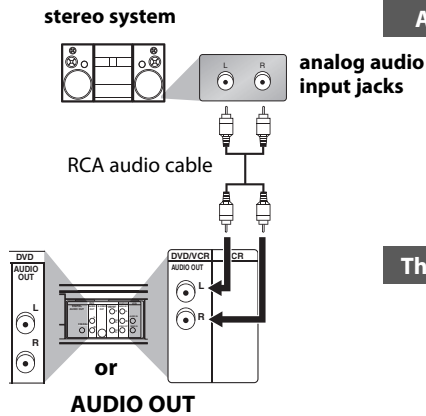

Audio

### Playing Multi Channel Digital Audio

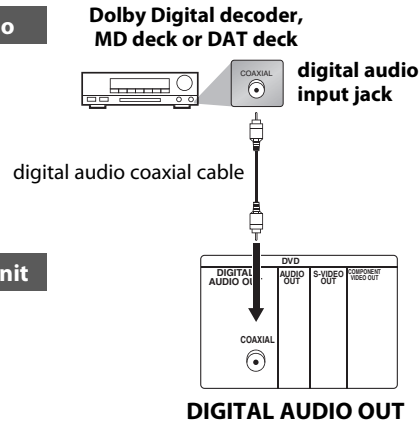

This unit

#### Supplied cables used in this connection are as follows:

- RCA audio cable (L/R) x 1
- Please purchase the rest of the necessary cables at your local store.

Connection	Setting	SETUP > QUICK > DOLBY DIGITAL
Connecting to a Dolby Digital decoder for Dolby Digital audio output.		BITSTREAM
Connecting to other device (an MD deck or DAT deck etc.) without Dolby Digital decoder.		PCM

\* To complete these settings, refer to pages 20-21.

#### Note:

- The audio source on a disc in a Dolby Digital multi channel surround format cannot be recorded as digital sound by an MD or DAT deck.
- By hooking this unit up to a Dolby Digital decoder, you can enjoy high-quality Dolby Digital multi channel surround sound as heard in the movie theaters.
- Playing back a DVD using incorrect settings may generate noise distortion and may also damage the speakers.

SETUP

## Connection to a Cable/Satellite Box

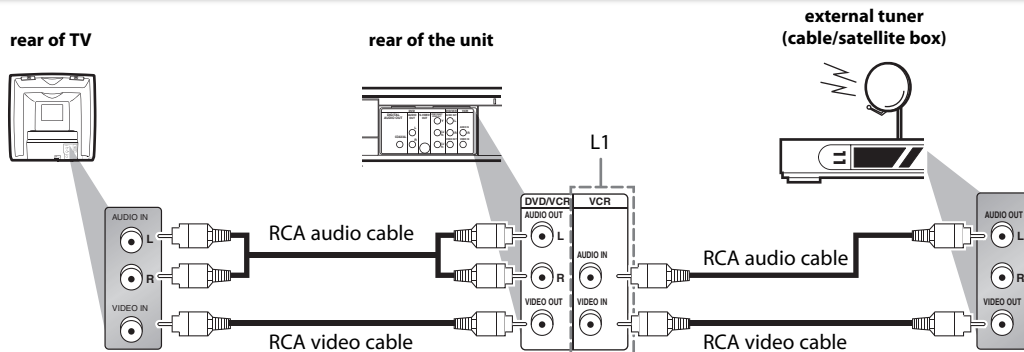

#### Using the unit with a cable/satellite box

1. Connect an RCA audio and video cables to the audio and video output jacks of your cable/satellite box and to the audio and video input jacks at the rear of the unit.
2. Press [INPUT SELECT] on your remote control until "L1" is displayed on your TV.

#### Note:

- Your cable/satellite box can be accessed only by connecting it to L1 (rear panel jacks) of the unit. Even if the unit is turned off, the signal from the external tuner is output to the TV through the unit.

L1: Rear panel terminals  
L2: Front panel terminals

Refer to "Front & Rear Terminals" on page 9 for more information.

#### Supplied cables used in this connection are as follows:

- RCA audio cable (L/R) x 1
  - RCA video cable x 1
- Please purchase the rest of the necessary cables at your local store.

#### Special note when connected to a cable/satellite box:

- Only the active channel on your cable/satellite box may be viewed or recorded when connected to this unit. Do not change channels during a recording. You cannot record on channel while viewing another.
- Always use the LEFT (white) audio output jack from the external tuner to ensure that the audio is mixed down correctly to mono for this unit. If you use the RIGHT (red) jack, you will record the right audio only.

EN

- 7 -

# Preparation for Use

## Turning on Unit for the First Time



Please note: most instructions in this manual refer to remote control use.

- 1 Be sure your TV's input is set to VIDEO. (Name may vary with TV manufacturer. See your TV manual for details.)



- 2 Select your on-screen language. Then press [▶] to continue.

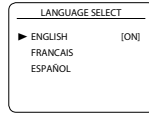

- 3 When "CLOCK SET" menu appears, go to step 2 in "Clock Setting" on this page.

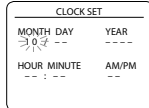

SETUP

## To Change the Selected On-screen Language

- 1 Press [SETUP] until the main menu appears.

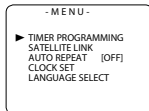

- 2 Select "LANGUAGE SELECT". Then press [▶] to go to next step.

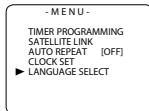

- 3 Select "ENGLISH", "FRANCAIS" or "ESPAÑOL". Then press [CLEAR/C.RESET].

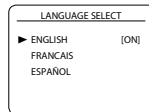

### Note:

- If you accidentally select Spanish or French and need English: Press [SETUP] and choose "SELEC. IDIOMA" or "SELECTION LANGUE". Press [▶] and select "ENGLISH". Finally, press [CLEAR/C.RESET].

## Clock Setting



- 1 Press [SETUP] and select "CLOCK SET". Then press [▶] to go to next step.

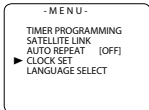

- If the clock is not set, the "CLOCK SET" menu appears when you press [SETUP]. In this case, go to step 2.

- 2 Select the current month. Then press [▶] to go to next step.

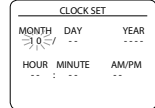

- 3 Select the current day. Then press [▶] to go to next step.

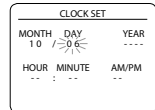

- 4 Select the current year. Then press [▶] to go to next step.

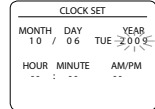

- 5 Select the current hour. Then press [▶] to go to next step.

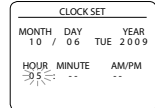

- 6 Select the current minute. Then press [▶] to go to next step.

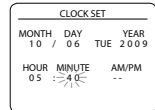

- 7 Select "AM" or "PM".

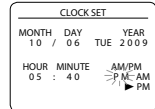
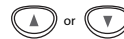

- 8 Press [SETUP] to exit the "CLOCK SET" menu.



### Note:

- To go back, press [◀] during steps 2 to 7.
- Clock setting will be lost after a power failure, or this unit has been unplugged for more than 30 seconds.



# Function Overview

## Front Panel Indicator Lights

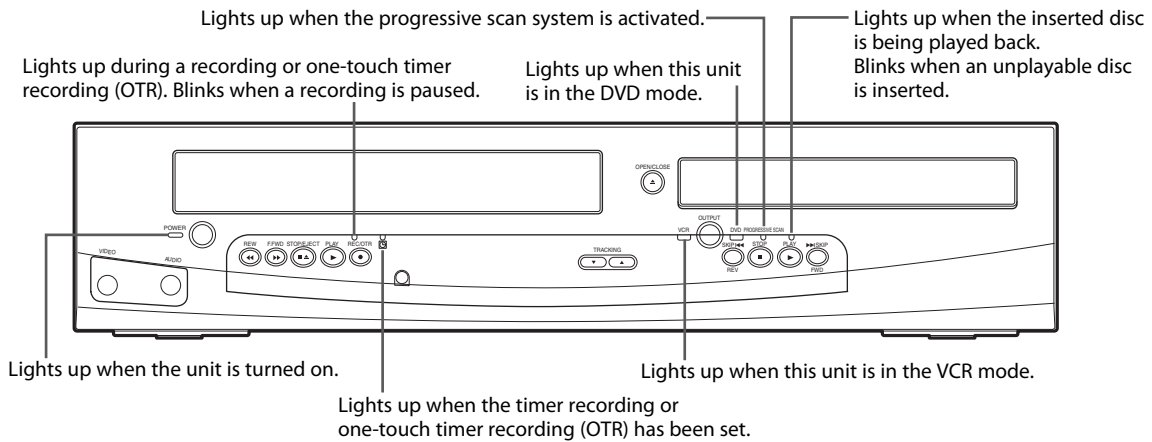

## Selecting DVD or VCR Operation

You must first select either DVD or VCR operation.

### VCR MODE

Press [VCR] on the remote control. (The VCR OUTPUT light will illuminate.)

### DVD MODE

Press [DVD] on the remote control. (The DVD OUTPUT light will illuminate.)

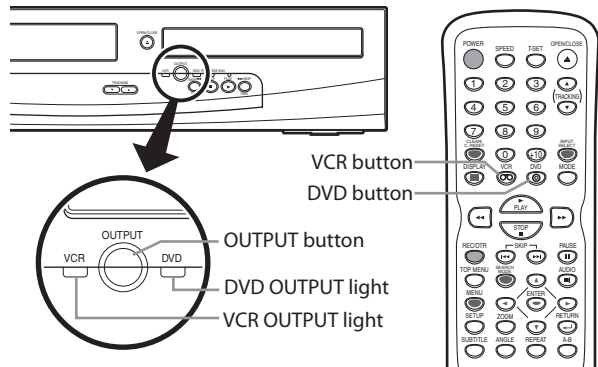

## Front & Rear Terminals

rear panel

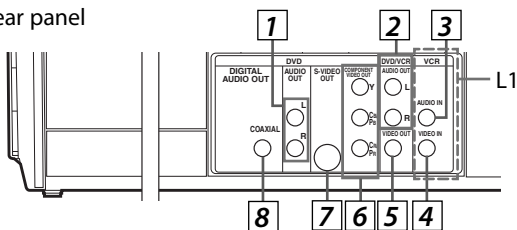

### 1: DVD AUDIO OUT\* (analog) jacks

Connect an audio cable from here to the audio input jack of your television or audio device.

### 2: DVD/VCR AUDIO OUT jacks

Connect an audio cable from here to the audio input jack of your television or audio device. Standard connection for DVD/VCR use.

### 3: VCR AUDIO IN jack

Connect a monaural audio cable from the audio output jack of your camcorder, VCR, etc. to here. After making the connection, press [INPUT SELECT] on the remote control. Select "L1" to activate the rear AUDIO IN jack, or "L2" to activate the front.

### 4: VCR VIDEO IN jack

Connect a video cable from the video output jack of your camcorder, VCR, etc. to here. After making the connection, press [INPUT SELECT] on the remote control. Select "L1" to activate the rear VIDEO IN jack, or "L2" to activate the front.

front panel

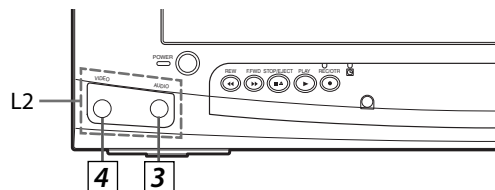

### 5: DVD/VCR VIDEO OUT jack

Connect a video cable from here to the VIDEO input jack of your television or audio device. Standard connection for DVD/VCR use.

### 6: COMPONENT VIDEO OUT\* jacks

Connect component video cables from here to the component video input jacks of your television.

### 7: S-VIDEO OUT\* jack

Connect an S-video cable from here to the S-video input jack of your television.

### 8: DIGITAL AUDIO OUT COAXIAL\* jack

Connect a digital audio coaxial cable from here to the digital audio input jack of your digital audio receiver.

\* For enhanced DVD viewing. DVD/VCR video and audio connection required to view cassette tapes.

### Note:

• Audio and video cables are included for both VCR and DVD viewing. You can enhance your DVD picture and sound quality with an S-video cable, component video cables, or a digital audio coaxial cable. **Please purchase the necessary cables at your local store.** (Refer to pages 6-7.)



## Remote Control

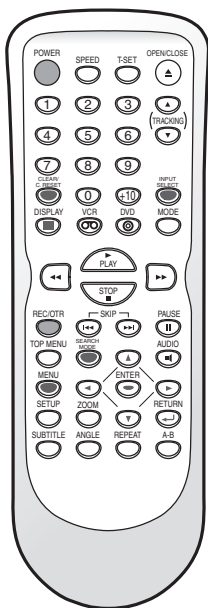

SETUP

### Installing the Batteries for the Remote Control

Install the batteries (AA x 2) matching the polarity indicated inside battery compartment of the remote control.

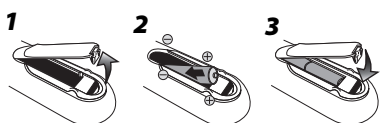

Keep in mind the following when using the remote control:

- Make sure that there are no obstacles between the remote control and the infra-red sensor window on the unit.
- The maximum operable ranges from the unit are as follows.
  - **Line of sight:** approx. 23 feet (7m)
  - **Either side of center:** approx. 16 feet (5m) within 30°
  - **Above:** approx. 16 feet (5m) within 15°
  - **Below:** approx. 10 feet (3m) within 30°

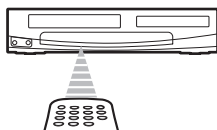

#### Note:

- Do not mix alkaline and manganese batteries.
- Do not mix old and new batteries.
- Always remove batteries from remote control if they are dead or if the remote control is not to be used for an extended period of time. This will prevent battery acid from leaking into the battery compartment.
- If you turn off this unit, [OPEN/CLOSE ▲] on the remote control is not available. Be sure to use [OPEN/CLOSE ▲] or [STOP/EJECT ■▲] on the unit.

Button (Alphabetical order)	Media	DVD mode		VCR mode
		DVD	CD MP3	VHS
1 2 3 4 5 6 7 8 9 0		• To select chapter or title directly.	• To select track or file directly.	—
◀ ▶		• To search forward/backward through a disc. • To begin slow forward/reverse playback in the pause mode.	• To search forward/backward through a disc.	• To forward/backward a tape. • To begin slow forward playback in the pause mode.
A-B		• To repeat between your chosen point of A and B.	• To repeat between your chosen point of A and B. (CD)	—
ANGLE		• To select camera angles on a disc.	—	—
AUDIO		• To select audio languages on a disc.	• To select "STEREO", "L-ch" or "R-ch". (CD)	—
CLEAR/C-RESET		• To clear the markers. • To clear numbers entered incorrectly. • To cancel the point for A-B repeat.	• To clear the markers. (CD) • To remove status number in program input. • To clear numbers entered incorrectly. • To cancel the point for A-B repeat. (CD)	• To exit the VCR menu. • To reset the tape counter.
DISPLAY		• To display the current disc mode.	• To display the current disc mode.	• To display the current time, tape counter, and L1 or L2.
DVD		• To select DVD output mode. • To activate DVD mode.	• To select the DVD output mode. • To activate DVD mode.	—
ENTER		• To move the cursor and determine its position.	• To move the cursor and determine its position.	• To select an item on the VCR menu. • To advance to the next VCR menu. • To go back one step during clock and timer programming.
INPUT SELECT		—	—	• To select input "L1" or "L2".
MENU		• To call up the disc menu on a disc.	• To call up the file list. (MP3)	—
MODE		• To set black level on/off. • To set virtual surround on/off.	• To arrange the playing order or play randomly. • To set virtual surround on/off.	—
OPEN/CLOSE ▲		• To open or close the disc tray.	• To open or close the disc tray.	• To eject the cassette tape from the cassette compartment.
PAUSE		• To pause disc playback. • To advance playback one frame at a time.	• To pause disc playback.	• To pause tape playback or recording. • To advance playback one frame at a time.
▶ PLAY		• To begin disc playback.	• To begin disc playback.	• To begin tape playback.
POWER		• To turn the unit on or to turn the unit into the standby mode. (To completely turn off the unit, you must unplug the AC power cord.)	• To turn the unit on or to turn the unit into the standby mode. (To completely turn off the unit, you must unplug the AC power cord.)	• To turn the unit on or to turn the unit into the standby mode. (To completely turn off the unit, you must unplug the AC power cord.)
REC/OTR		—	—	• To start recording or one-touch timer recording. (OTR)
REPEAT		• To play back a chapter or title repeatedly.	• To play back a track or disc repeatedly. (CD) • To play back a file, folder or disc repeatedly. (MP3)	• To select the repeat mode on/off.
RETURN		• To return to the previous operation in menu.	• To return to the previous operation in menu.	—
SEARCH MODE		• To search chapter, title or time. • To set or search the markers.	• To search track. • To search time. (CD) • To set or search the markers. (CD)	• To call up the index or time search menu.
SETUP		• To call up the DVD menu.	• To call up the DVD menu.	• To call up the VCR menu.
SKIP		• To skip chapters or titles.	• To skip tracks or files.	—
SPEED		—	—	• To select the recording speed.
STOP		• To stop playback.	• To stop playback.	• To stop playback or recording.
SUBTITLE		• To select subtitles on a disc.	—	—
TOP MENU		• To call up the top menu on a disc.	• To return to the top file of the highest hierarchy in the program and file list. (MP3)	—
TRACKING		—	—	• To adjust the tracking manually during playback.
T-SET		—	—	• To put the VCR into standby mode for a timer recording.
VCR		—	—	• To select the VCR output mode. • To activate VCR mode.
ZOOM		• To magnify part of a picture. (2x/4x)	—	—



# VCR FUNCTIONS

## Playback

Before: Turn on the TV.



<p><b>1</b> Insert a cassette tape into this unit.</p>	<p><b>2</b> To start playback</p>
<p><b>3</b> To stop playback</p>	<p><b>4</b> To eject the cassette tape</p>

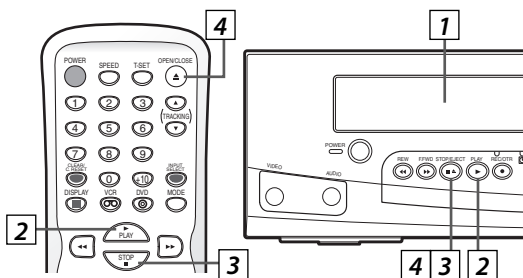

### Note:

- When a cassette tape without a record tab is inserted, the unit will start playback automatically.
- Tracking will be automatically adjusted upon playback. To adjust the tracking manually, press [TRACKING ▲ / ▼] during playback.

## Other Operations

### To cue or review picture during playback (picture search)

Use [▶▶] or [◀◀] ([F.FWD ▶▶] or [REW ◀◀] on this unit).

- Press it again and the unit will search in super high speed. (in the SLP mode only)

### To freeze the picture on TV screen during playback (still mode)

Press [PAUSE II]. Each time you press the button, the picture will be forwarded by one frame.

- If the picture begins to vibrate vertically in the still mode, stabilize the picture by using [TRACKING ▲ / ▼].
- If the picture is distorted or rolling vertically, adjust the vertical hold control on your TV if equipped.

### To Reset the Cassette Tape Counter (counter reset)

Press [DISPLAY] to display the cassette tape counter on the TV. Press [CLEAR/C.RESET] to reset the counter to "0:00:00".

### To play back in slow motion (slow mode)

Press [PAUSE II] during playback, then press [▶▶] ([F.FWD ▶▶] on this unit).

- If you want to change speed in slow mode, press [▶▶] or [◀◀] ([F.FWD ▶▶] or [REW ◀◀] on this unit), slow speed will be more fast and slow mode.
- If the noise bars appear on the TV screen, you can reduce it by using [TRACKING ▲ / ▼].

### To rewind the cassette tape automatically (auto rewind)

When a cassette tape reaches its end during playback, fast-forward or recording (except timer recording and one-touch timer recording), the cassette tape will automatically rewind to the beginning. After rewinding finishes, the unit will eject the cassette tape.

### Note:

- To prevent damage to the cassette tape, still or slow mode will automatically stop after 5 minutes.
- To return to playback from the picture search, still or slow mode, press [PLAY ▶].

## Index Search

To search by index mark. The index mark will be made automatically at the beginning of each recording.



• Insert a cassette tape into this unit.

- Press [SEARCH MODE] once.
- To select index mark
- To rewind
 

To fast forward
- When index mark is reached, playback automatically begins.

### Note:

- The time gap between index marks should be more than 1 minute for SP mode, 2 minutes for LP mode and 3 minutes for SLP mode.

## Time Search

To search by length of time.



• Insert a cassette tape into this unit.

- Press [SEARCH MODE] twice.
- Select the desired length of time for fast forwarding or rewinding.
- To rewind
 

To fast forward
- When selected length of time is reached, playback will start automatically.

### Note for Index Search & Time Search:

- These functions are not available during recording.
- Press [STOP ■] to stop the search.
- If a cassette tape ends during a search, your search will be canceled and the cassette tape will rewind to the beginning.

VCR FUNCTIONS

## Auto Repeat

When "AUTO REPEAT" is set to "ON", the cassette tape will automatically rewind and start over when it reaches the end. This will continue until auto repeat function is turned off.



1 Press **[SETUP]**, and choose "AUTO REPEAT".

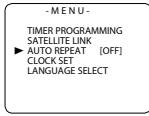

2 Press **[▶]** to "AUTO REPEAT" to set "ON" or "OFF".



Press **[SETUP]** to exit.

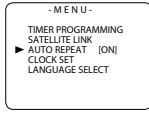

### Note:

- The auto repeat function can also be set "ON" or "OFF" by pressing **[REPEAT]** on the remote control.
- To cancel auto repeat function, follow step 1 above. Then, press **[▶]** so that "OFF" appears beside "AUTO REPEAT". Press **[SETUP]** to exit.
- The auto repeat playback will start automatically if you select "AUTO REPEAT" to "ON" in the stop mode.

## Recording

This unit has no tuner system so it cannot receive TV broadcasts without external tuner or such devices.

### Note:

- You can also set to external tuner. Refer to "Satellite Link" on page 14.

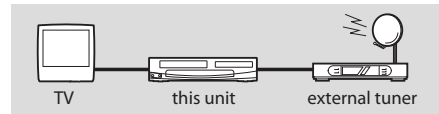

## Recording & One-touch Timer Recording (OTR)



1 Insert a recordable cassette tape.

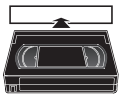

2 Press **[INPUT SELECT]** until "L1" or "L2" is displayed on the TV screen. Select "L1" to activate rear input jacks. Select "L2" to activate front input jacks.



See note on the right.

3 Press **[SPEED]** to select the desired tape speed.



Tape speed	Recording / playback time		
Type of tape	T60	T120	T160
SP mode	1hour	2hours	2-2/3hours
SLP mode	3hours	6hours	8hours

4 Press **[REC/OTR]** until desired recording time is selected.

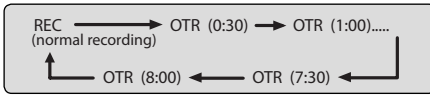

5 Press **[STOP ■]** to stop recording.



6 Press **[OPEN/CLOSE ▲]** to eject the recorded cassette tape.



You **CANNOT** dub a DVD to a video cassette tape.

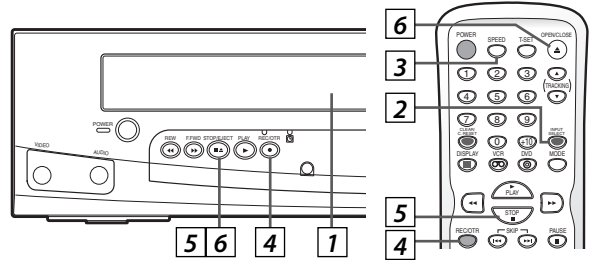

### To stop recording temporarily (Pause mode)

Press **[PAUSE ■■]**.

- During the recording in pause mode, 5 ■ marks appear on the TV screen. Each ■ mark represents 1 minute.
- Press it again to resume recording.
- Pause mode will be automatically canceled after 5 minutes to prevent damage to the cassette tape and the video head.

### Note:

- Do not change the external tuner's channel while you are recording. You **CANNOT** watch one channel and record another at the same time.
- Connect your external tuner to the L1 (rear panel) jacks of the unit. Connect camcorders and other such devices to the L2 (front panel) jacks. Refer to page 7, 9.

### Accidental Erasure Prevention

To prevent accidental recording, remove erase-protection tab of the cassette tape. To record on it later, cover the hole with adhesive tape.

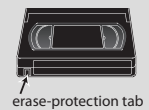

## Timer Recording



- Insert a recordable cassette tape.
- Make sure to turn on the external tuner.

1 Press **[SETUP]**. Select "TIMER PROGRAMMING".

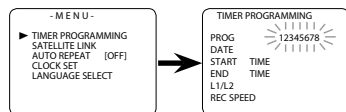
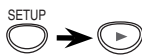

Available program number flashes.

2 Select an empty program number. Then press **[▶]** to go to next step.

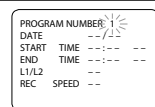



**3** Select "ONCE", "DAILY" (Mon-Fri), or "WEEKLY". Then press **[▶]** to go to next step.

PROGRAM NUMBER 1  
 ▶ ONCE  
 DAILY  
 WEEKLY

**4** Select the desired date. Then press **[▶]** to go to next step.

ONE TIME PROGRAM  
 PROGRAM NUMBER 1  
 DATE 10/06 TUE  
 START TIME ---:--:--  
 END TIME ---:--:--  
 L1/L2 ---  
 REC SPEED --

• You can program the unit to record up to 8 programs, for up to a year in advance.

**5** Select the desired starting time (hour). Then press **[▶]** to go to next step.

ONE TIME PROGRAM  
 PROGRAM NUMBER 1  
 DATE 10/06 TUE  
 START TIME 07:30  
 END TIME ---:--:--  
 L1/L2 ---  
 REC SPEED --

**6** Select "AM" or "PM". Then press **[▶]** to go to next step.

ONE TIME PROGRAM  
 PROGRAM NUMBER 1  
 DATE 10/06 TUE  
 START TIME 07:30 PM  
 END TIME ---:--:--  
 L1/L2 ---  
 REC SPEED --  
 AM  
 PM

**7** Repeat the procedure in steps 5 and 6 to set the ending time.

**8** Select "L1" or "L2". Then press **[▶]** to go to next step.

ONE TIME PROGRAM  
 PROGRAM NUMBER 1  
 DATE 10/06 TUE  
 START TIME 07:30 PM  
 END TIME 08:30 PM  
 L1/L2 1  
 REC SPEED --

**9** Select recording speed. Then press **[CLEAR/C.RESET]**.

ONE TIME PROGRAM  
 PROGRAM NUMBER 1  
 DATE 10/06 TUE  
 START TIME 07:30 PM  
 END TIME 08:30 PM  
 L1/L2 L1  
 REC SPEED SP  
 --SP--  
 SLP

• To set another program after step 9, press **[▶]**. Then continue with step 2.

**10** Press **[T-SET]** to set the timer standby mode.

• indicator on this unit lights up and the unit goes to the DVD mode.

**Note:**

- To go back one step, press **[◀]** during steps 3 to 9.
- Select "L1" to activate rear input jacks. Select "L2" to activate front input jacks.

**To check, correct or cancel a timer program**

- 1) Press **[T-SET]** then, **[VCR Ⓞ]** on the remote control.
- 2) Press **[SETUP]** to call up the main menu.
- 3) Select "TIMER PROGRAMMING" by using **[▲ / ▼]**, then press **[▶]**.
- 4) Select the program number which you want to check by using **[▲ / ▼]**. The details of the program you selected will appear on the TV screen.
  - Go to the digit you want to change by using **[◀ / ▶]**. Then, enter correct numbers by using **[▲ / ▼]**.
  - You may cancel the entire program by pressing **[◀]** while the program number blinks.
- 5) Press **[CLEAR/C.RESET]** to exit.
- 6) Press **[T-SET]** to return to the timer standby mode.

**To cancel a timer recording in progress**

Press **[STOP/EJECT ■ ▲]** on the unit.

VCR FUNCTIONS

**Notes for Timer Recording & One-touch Timer Recording (OTR)**

- If a cassette tape is not in the unit or does not have the erase-protection tab, indicator on this unit blinks and timer recording cannot be performed. Please insert a recordable cassette tape.
- When timer recordings are set, indicator on this unit lights up. To use the VCR as usual until the time for the recording, press **[T-SET]** so that indicator lights off.

**After an one-touch timer recording or a timer recording has been set, this unit operates as follows:**

- If a cassette tape runs out before an one-touch timer recording or a timer recording is finished, the unit ejects the cassette tape. Press **[T-SET]** on the remote control or **[STOP/EJECT ■ ▲]** on the unit, then press **[VCR Ⓞ]** to activate the VCR function again.
- Once the unit turns to the timer standby mode, no VCR functions are available until **[T-SET]** is pressed.
- To cancel the timer standby mode, press **[T-SET]** on the remote control or **[STOP/EJECT ■ ▲]** on the unit, then press **[VCR Ⓞ]** to activate the VCR function again.

**When an one-touch timer recording or a timer recording is completed...**

- If auto power off for DVD has been activated and there are timer recordings on standby, the unit turns off automatically, and indicator on this unit lights to indicate the unit is in the timer standby mode.
- indicator on this unit flashes if there are no more timer recordings on standby.
- If auto power off for DVD has **NOT** been activated, the unit goes to the DVD mode and all the VCR functions will be unavailable. All the DVD functions are available during one-touch timer recording, timer standby mode and timer recording.
- Press **[STOP/EJECT ■ ▲]** on this unit or **[T-SET]** on the remote control to use the VCR when the unit is turned off.
- Press **[OUTPUT]** on this unit or **[VCR Ⓞ]** on the remote control to use the VCR when the unit is turned on. In case timer recording is in standby mode, press **[STOP/EJECT ■ ▲]** on this unit or **[T-SET]** on the remote control, and then press **[OUTPUT]** on this unit or **[VCR Ⓞ]** on the remote control.

**If you want to use the DVD player during a timer recording or while indicator on this unit is on or blinking.**

- Press **[POWER]** to turn on the unit. Press **[DVD ⊙]** on the remote control to choose DVD mode, then continue with the other DVD features as described in this manual.

**Note for timer recording:**

- If there is a power failure or the unit is unplugged for more than 30 seconds, clock setting and all timer programs will be lost.



## Satellite Link

You can set the unit to start recording whenever it detects a video signal from the external tuner.

### Preparing for the Satellite Link Timer Recording:

#### Preparation on the tuner

- Satellite link accepts only the connection from L1 (rear) with the external tuner. (The connection from L2 cannot read any signals from the cable/satellite box.)
- The external tuner should be equipped with some kind of timer function. Using timer function of the tuner, set it to output audio/video signals when it comes to the time you want to start recording, and stop output audio/video signals when it comes to the time you want to finish recording. Refer to the tuner's manual on how to set the timer.
- Make sure to turn off the tuner when you finish setting.

#### Preparation on this unit

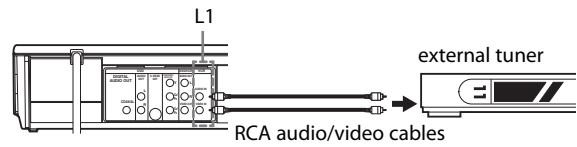

- 1 Press **[SPEED]** to select the desired tape speed.

SPEED	Tape speed		Recording / playback time		
	Type of tape		T60	T120	T160
SP	SP mode		1hour	2hours	2-2/3hours
	SLP mode		3hours	6hours	8hours

- 2 In stop mode, press **[SETUP]**.



- 3 Select "SATELLITE LINK". Then press **[▶]** to go to next step.



- M E N U -  
 TIMER PROGRAMMING  
 SATELLITE LINK  
 AUTO REPEAT (OFF)  
 CLOCK SET  
 LANGUAGE SELECT

- 4 Set the desired start hour. Then press **[▶]** to go to next step.



SATELLITE LINK  
 00 AM

- The hour can be selected from 1-12 with AM or PM.
- When the external tuner signal is stopped, recording will be stopped.

- 5 Set the desired start minutes. If you wish to go back to the left, press **[◀]**.



SATELLITE LINK  
 01:00 PM

- 6 Press **[▶]** to set satellite link standby mode.



SATELLITE LINK  
 01:30 PM  
 [ON]

- indicator on this unit lights up and the unit goes to the DVD mode. If you do not use DVD function, turn off the unit.
- Satellite unit must be turned on for VCR satellite link to start. If cable/satellite box is not set to output signals, satellite link will remain in standby mode.

#### To cancel the satellite link function in standby mode:

Press **[T-SET]** on the remote control or **[STOP/EJECT ■ ▲]** on this unit.

#### To cancel the satellite link function while the satellite link recording is in progress:

Press **[STOP/EJECT ■ ▲]** on this unit.

### Note:

- If you have not set the clock, "CLOCK SET" menu will appear at step 2. Refer to "Clock Setting" on page 8.
- You cannot set the ending time for the satellite link timer recording on this unit.
- Recording picture will be distorted if the copy protection signal is being detected during satellite link timer recording.
- When a regular timer recording and the satellite link timer recording are overlapped, those recordings are recorded as illustrated below.

e.g.) In case of the satellite link timer recording is overlapped on the existing timer recording.

timer recording	
satellite link	
recording result	

e.g.) In case of the timer recording is programmed in the middle of the satellite link timer recording

timer recording	
satellite link	
recording result	

e.g.) In case of the timer recording is overlapped on the existing satellite link timer recording.

timer recording	
satellite link	
recording result	

## Copying a Cassette Tape

**Warning:** Unauthorized recordings of copyrighted cassette tapes may be an infringement of copyright laws.

- 1) Insert a pre-recorded cassette tape into another external device for playback.
- 2) Insert a recordable cassette tape into this unit for recording.
- 3) Press **[SPEED]** on the remote control to select recording speed (SP or SLP).
- 4) Press **[INPUT SELECT]** on the remote control to select L1 or L2. Choose L1 if device is connected to rear input jacks, or L2 if connected to the front. Refer to "Front & Rear Terminals" on page 9 for more details.
- 5) Press **[REC/OTR]** on the unit.
- 6) Press "PLAY" button on the external device.
- 7) To stop recording, press **[STOP/EJECT ■ ▲]** on this unit, then stop playback of the external device.

output jacks of external device

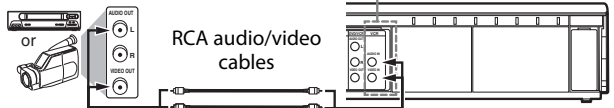

You can use a video disc player, cable/satellite box or other audio/video component with audio/video output jacks.

### Note:

- For best results during dubbing, use buttons on this unit whenever possible. The remote control might affect another device's operation.
- Always use video-quality shielded cables with RCA-type connectors. Standard audio cables are not recommended.
- L2 input jacks are on the front of this unit.

# DVD FUNCTIONS

## Playback

### Before:

Turn on the TV, amplifier and any other components which are connected to this unit. Make sure the TV and audio receiver are set to the correct channel.



(MP3 on page 16)

<b>1</b>  POWER	<b>2</b> Insert a disc with label facing up. 
<b>3</b> To start playback  PLAY	<b>4</b> To stop playback  STOP

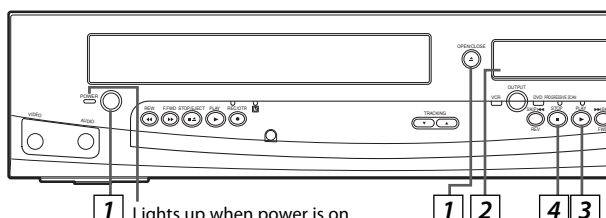
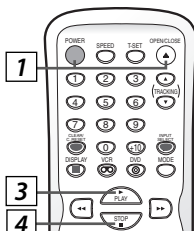

### Note:

- When you play a CD-RW/-R with MP3 files, details on page 16.
- "⊘" may appear at the top-right on the TV screen when the operation is prohibited by the disc or this unit.
- Some DVD may be played from title 2 or 3 due to specific programs.
- During the playback of a 2-layered disc, pictures may stop for a moment. This happens while the 1st layer is being switched to the 2nd layer. This is not a malfunction.
- You can change the on-screen language for DVD function in "PLAYER MENU" menu. Refer to page 20.

### Disc Menu



Some discs contain menus which allow you to customize DVD playback. Use [▲ / ▼ / ◀ / ▶] to select an item, then press [ENTER] (or [PLAY ▶]).

### Calling Up a Menu Screen during Playback



- Press [MENU] to call up the disc menu.
- Press [TOP MENU] to call up the title menu.

### Note:

- Menu operations may vary depending on the disc. Refer to the manual accompanying the disc for details.

### Resume Playback



Press [STOP ■] during playback. Resume message will appear on the TV screen.

Press [PLAY ▶], playback will resume from the point at which playback was stopped.

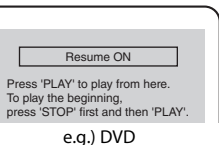

### Note:

- To cancel resume, press [STOP ■] one more time in the stop mode.
- For MP3, playback will resume from the beginning of the track at which playback was stopped.
- The resume playback information stays on even when the power is turned off, as long as the disc stays in the unit.

### Paused and Step-by-Step Playback



Press [PAUSE ■] during playback. To continue playback, press [PLAY ▶].



The disc goes forward by one frame each time [PAUSE ■] is pressed in the pause mode. To continue playback, press [PLAY ▶].

### Note:

- For DVD, set "STILL MODE" to "FIELD" in "DISPLAY" menu if pictures in the pause mode are blurred. Refer to pages 20-21.

### To use [SKIP ◀◀ / REV], [▶▶ SKIP / FWD] on this unit



Press once to skip chapters, tracks or titles to a desired point.

### Fast Forward / Reverse Search



Press [▶▶] or [◀◀] repeatedly during playback to select the required forward or reverse speed.

**To use [SKIP ◀◀ / REV], [▶▶ SKIP / FWD] on this unit**  
Pressing and holding [SKIP ◀◀ / REV] or [▶▶ SKIP / FWD] on this unit will also change forward or reverse playback speed. To continue playback, press [PLAY ▶].

### Note:

- For DVD, fast forward or reverse search speed is different depending on the disc. Approximate speed is 1(2x), 2(8x), 3(20x), 4(50x), 5(100x).
- For audio CD and MP3, approximate speed is 1(2x), 2(8x), 3(30x).

### Slow Forward / Reverse Search



Press [▶▶] or [◀◀] repeatedly in the pause mode to select the required forward or reverse speed.

**To use [SKIP ◀◀ / REV], [▶▶ SKIP / FWD] on this unit**  
Pressing and holding [SKIP ◀◀ / REV] or [▶▶ SKIP / FWD] on this unit in the pause mode will also change forward or reverse playback speed. To continue playback, press [PLAY ▶].

### Note:

- Slow forward or reverse speed is different depending on the disc. Approximate speed is 1(1/16x), 2(1/8x), 3(1/2x).
- Set "STILL MODE" to "FIELD" in "DISPLAY" menu if pictures in the slow playback mode are blurred. Refer to pages 20-21.

### Zoom



- 1) Press [ZOOM] during playback.
- 2) Press [ZOOM] repeatedly to select the required zoom factor: 2x, 4x or off.



- 3) Press [▲ / ▼ / ◀ / ▶] to slide the zoomed picture across the TV screen.
- 4) To exit zoom mode, press [ZOOM] to select OFF.

### Note:

- Zoom function does not work while the disc menu is displayed.
- 4x zoom is not available on some discs.
- The picture may be distorted when you press [PAUSE ■] or [◀◀] repeatedly in the zoom mode.
- In the zoom mode, it automatically changes [TV] 2x (4x) to the zoomed position guide.

# MP3 Playback

MP3 is a method of compressing files. You can copy MP3 files on CD-RW/-R from the computer and play back the files on this unit.



Insert a CD-RW/-R with MP3 files, the file list will automatically appear on the TV screen. Press [MENU] when you want to call up the file list again while CD-RW/-R with MP3 files is already inserted.

1 When selecting the folder:



- Press [▶] when you want to go to the next hierarchy.
- Press [◀] when you want to go back to the previous hierarchy (except for the top hierarchy).

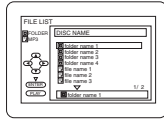

2 Press [STOP] once to stop MP3 playback temporarily.



Refer to "Resume Playback" on page 15.

## Note:

- Depending on some sections, it may take a while to be recognized.
- Press [TOP MENU] to return to the first item.
- Folders and MP3 files are displayed respectively as [ ] and [ ].
- A maximum of 255 folders or 999 files may be recognized on one disc.
- Up to 8 hierarchies can be recognized in one folder. File in the 9th or deeper hierarchies cannot be played back.

## This unit recommends files recorded under the following circumstances:

- Sampling frequency: 44.1kHz or 48kHz
- Constant bit rate: 32kbps ~ 320kbps
- For MP3 file recorded in VBR (variable bit rate), the unit may not display the actual elapsed time.

# On-Screen Display

You can check the information about the current disc by pressing [DISPLAY] on the remote control.

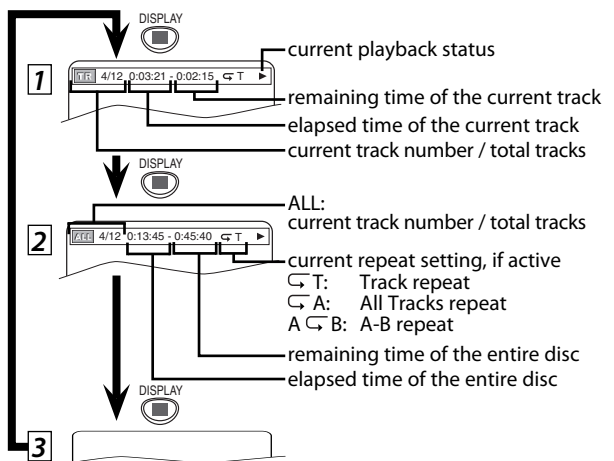
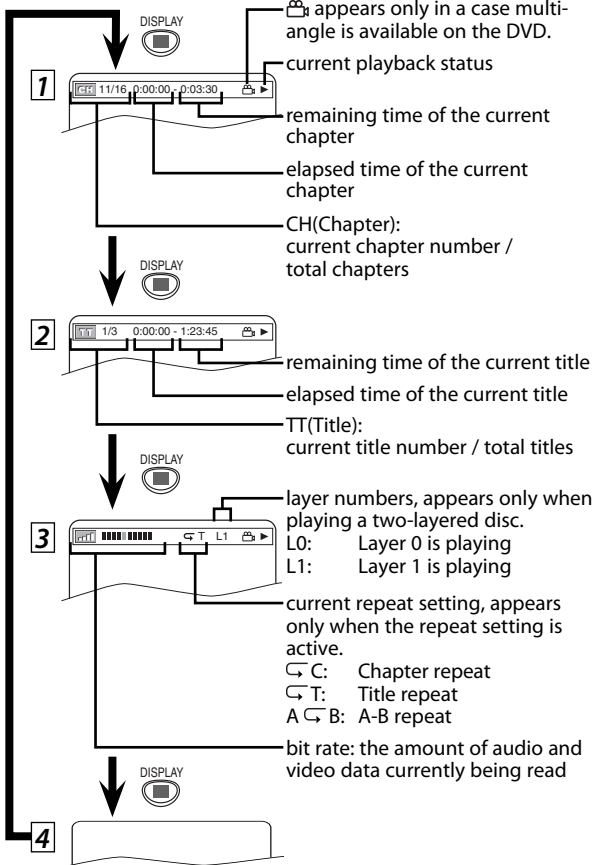

## Note:

- When you are playing a disc in program or random mode, [ ] PROGRAM (or RANDOM) will be displayed instead of [ ].

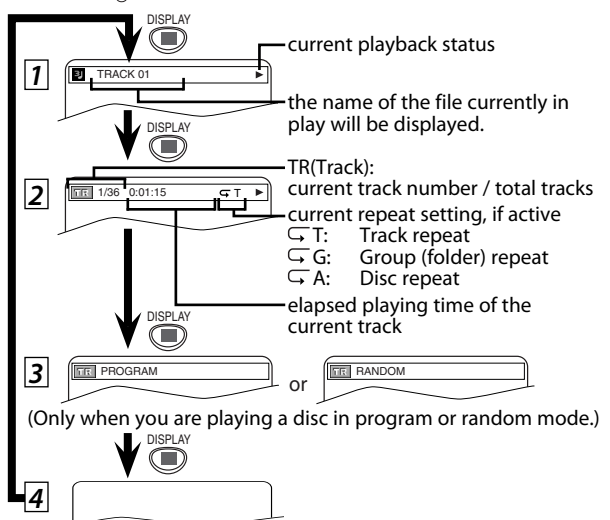



# Search Functions

Search function does not work during programmed or random playback.

## Using Track Search



1 Press [SEARCH MODE].

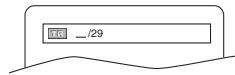

2 Select track number by using [the Number buttons] within 30 seconds.

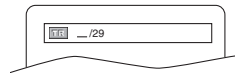

- For the disc with less than 10 tracks, press the track number directly.
- For discs with more than 10 but less than 99 tracks, to play back single-digit track, press [0], then the track number (e.g., for track 3, press [0], [3]). To play back a double-digit track, press the track number.
- For discs with more than 100 tracks, to play back a single or a double-digit track, press [0] first, then the track number (e.g., for track 3, press [0], [0], [3], and for track 26, press [0], [2], [6]). To play back a triple-digit track, press the track number.

## Using [SKIP] [LEFT], [RIGHT]

1 Press [SKIP] [LEFT], [RIGHT] during playback.

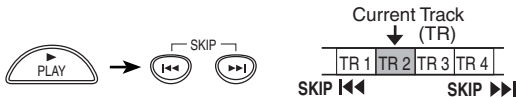

### Note:

- [+10] can also bring the track search display, except for the disc with less than 10 tracks. For such a disc, track search can be performed by just pressing the track number.
- For audio CD and MP3, track search is not available for programmed and random playback.

## Using Title / Chapter Search



1 Press [SEARCH MODE] once for the chapter search. Press [SEARCH MODE] twice for the title search.

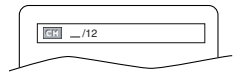
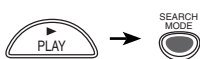

2 Select title/chapter number by using [the Number buttons] within 30 seconds.

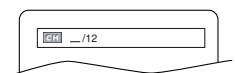

## Using [SKIP] [LEFT], [RIGHT]

1 Press [SKIP] [LEFT], [RIGHT] during playback.

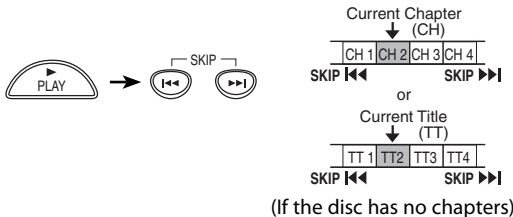

### Note:

- Depending on the disc being played back, this function can also be performed by directly entering the desired chapter number with [the Number buttons]. Refer to the manual accompanying the disc.

## Using Time Search



1 Press [SEARCH MODE] repeatedly until the time search display appears.

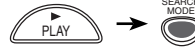

2 Select a desired disc time by using [the Number buttons] within 30 seconds.



### Note:

- When there is no need to enter a number, "0" appears automatically. For example, "0: 0: \_" appears in the time search display if the total time of the title or track is less than 10 minutes.
- Press [CLEAR/C.RESET] to erase the incorrect input at step 2.
- For audio CD, time search is not available for programmed and random playback.

## Marker Setting



This function allows you to assign a specific point on a disc to be called back later.

### To set a marker

1 Press [SEARCH MODE] repeatedly until the marker display appears.

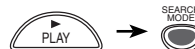

2 Select a marker.

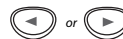

3 Press [ENTER].

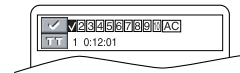

### To return to the marker later

1 Press [SEARCH MODE] repeatedly until the marker display appears.

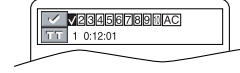

2 Select the marker.

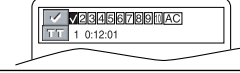
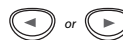

3 Press [ENTER] at the desired marker.

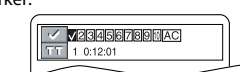

### To exit the marker screen

1 Press [RETURN].



### Note:

- The marker display will disappear in about 30 seconds when there is no output.
- To clear a marker, select the marker to be cleared at step 2 in the section "To set a marker" or "To return to the marker later" and then press [CLEAR/C.RESET].
- Opening the disc tray or turning off the power will erase all markers.
- Selecting "AC" at step 2 in the section "To set a marker" or "To return to the marker later" will also erase all markers.

# Repeat / Random / Programmed Playback

## Repeat Playback



Repeat function is available only during playback.

- 1 Press **[REPEAT]** during playback.



Each time you press **[REPEAT]**, repeat function changes as example below.

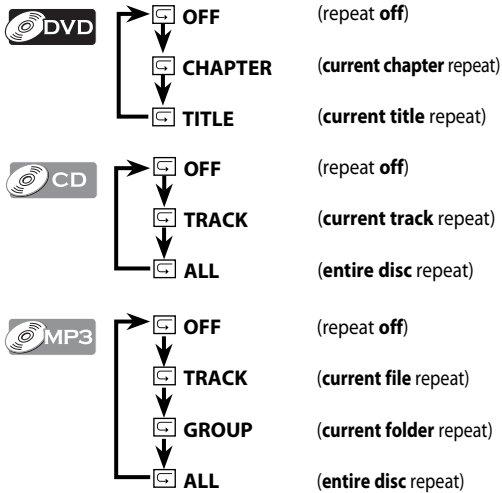

### Note:

- Repeat setting (except "ALL") will be cleared when moving to another title, chapter, track/file or folder.
- This function is not available with some discs or during repeat A-B playback.

## Repeat A-B Playback



Repeat function is available only during playback.

- 1 Press **[A-B]** at your desired starting point (A).



- 2 Press **[A-B]** at your desired ending point (B).

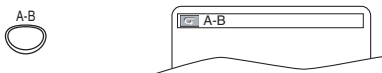

- Point B should be in the same title or track as point A.

### Note:

- To exit the sequence, press **[A-B]** so that "OFF" appears.
- To cancel point A, press **[CLEAR/C.RESET]** at step 1.
- This function is not available in the other repeat modes.

## Random Playback



This function shuffles the playing order of tracks instead of playback in sequence.

- 1 Press **[MODE]** twice.



- 2 Press **[PLAY ▶]** to start random playback.

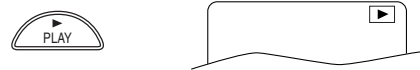

### Note:

- To repeat the current track in the random mode, press **[REPEAT]** repeatedly until "TRACK" appears during playback.
- To repeat the entire random selections, press **[REPEAT]** repeatedly until "ALL" appears during playback.
- During random playback, you cannot go back to the previous track.

## Programmed Playback



You may determine the order in which tracks will play back.

- 1 Press **[MODE]** once.



- 2 Using **[▲ / ▼]** to select desired track. Press **[ENTER]**.

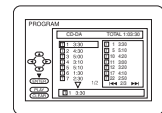

- Up to 99 tracks can be programmed.
- If eight or more tracks were in a program, use **[SKIP ◀▶]** to see all the tracks.
- While an MP3 folder is open:
  - Press **[▶]** when you want to go to the next hierarchy.
  - Press **[◀]** when you want to go back to the previous hierarchy (except for the top hierarchy).

- 3 Press **[PLAY ▶]** to start programmed playback.

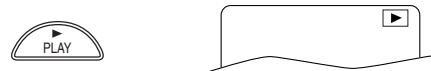

### Note:

- Press **[CLEAR/C.RESET]** at step 2 to erase the most recently entered track.
- To erase all programmed tracks at once, select "ALL CLEAR" and press **[ENTER]** at step 2.
- While a program is being played back, **[STOP ■]** works as follows:
  - Press **[STOP ■]** and **[PLAY ▶]** next, so that the programmed playback restarts from the current point. MP3 playback restarts from the beginning of the current file.)
  - Press **[STOP ■]** twice and **[PLAY ▶]** next, so that playback restarts from the first track in the original order. However, your programmed playback can be restarted when you follow the above steps. (Your programs are still stored until either the disc tray is open or power is turned off.)
- To repeat the current track in the program, press **[REPEAT]** repeatedly until "TRACK" appears during playback.
- To repeat the entire program, press **[REPEAT]** repeatedly until "ALL" appears during playback.

# Special Settings

## Subtitle Language



This unit allows you to select a subtitle language (if available) during DVD playback.

- 1 Press [SUBTITLE] during playback.

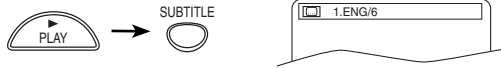

Each time you press [SUBTITLE], subtitle language changes as example below.

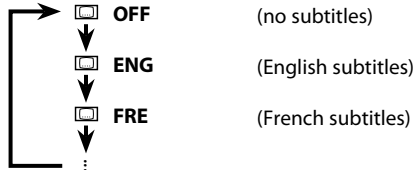

### To cancel subtitle

- 1 Press [SUBTITLE] during playback.

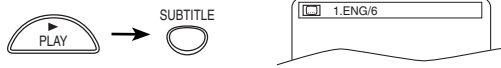

- 2 Press [◀/▶] to set subtitle to "OFF".



### Note:

- If your language is not shown after pressing [SUBTITLE] several times, the disc may not have that language. However, some discs have the subtitle language setting on the disc menu. (Operation varies depending on the discs, so refer to the manual along with the disc.)
- When "NOT AVAILABLE" appears on the TV screen, it means no subtitle is recorded on the scene.
- If you choose a language that has a 3-letter language code, the code will be displayed every time you change the subtitle language setting. If you choose any other languages, '---' will be displayed instead. Refer to page 24.
- Some discs will only allow you to change the subtitle from the disc menu. Refer to the manual accompanying the discs for details.

## Audio Language



This unit allows you to select an audio language (if multiple languages are available) during DVD playback.

- 1 Press [AUDIO] to change audio language.



Each time you press [AUDIO], the audio language changes as example below.



### Note:

- If your language is not shown after pressing [AUDIO] several times, the disc may not have that language. However, some discs allow audio language setting on the disc menu. (Operation varies depending on the disc, so refer to the manual along with the disc.)
- When "OFF" appears on the TV screen, it means audio language is not available.
- Some discs will only allow you to change the audio setting from the disc menu. Refer to the manual accompanying the discs for details.

## Camera Angles



Some DVD may contain scenes which have been shot simultaneously from various angles. You can change the camera angle if appears on the TV screen. If the "ANGLE ICON" is set to "OFF" in "OTHERS" menu, will not appear. Refer to pages 20-22.

- 1 Press [ANGLE] during playback.



Each time you press [ANGLE] or [◀/▶], camera angle changes.

## Black Level Setting



Adjust the black level to make the dark areas of the TV picture brighter.

- 1 Press [MODE] during playback.



- 2 Press [ENTER] to adjust the black level.



ON: makes the dark areas brighter.  
OFF: shows the original picture as recorded.

- 3 Press [RETURN] to exit.



## Stereo Sound Mode



This unit allows you to select a sound mode during CD playback.

- 1 Press [AUDIO] during CD playback.



Each time you press [AUDIO], sound mode changes as example below.

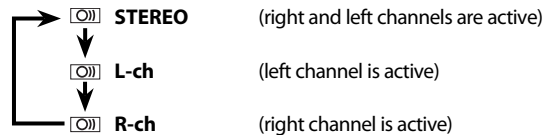

## Virtual Surround



You can enjoy stereophonic virtual world on your existing 2 channel stereo system.

- 1 Press [MODE] twice (once for CD and MP3) during playback.



- 2 Press [ENTER] for the desired effect.

1: natural effect  
2: emphasized effect  
OFF: no effects (original sound)



- 3 Press [RETURN] to exit.



### Note:

- For audio CD, virtual surround will not be effective if the sound mode is set to something other than "STEREO". Refer to "Stereo Sound Mode".
- For DVD when playing back 96kHz with virtual surround function, the sound will be down sampled to 48kHz.

# DVD Setting

## QUICK Menu

You can select the "PLAYER MENU", "TV ASPECT", "PROGRESSIVE" or "DOLBY DIGITAL" from "QUICK" menu quickly.

**1** Press [SETUP] in the stop mode.

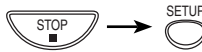

SETUP menu  
Confirm that "QUICK" is selected.

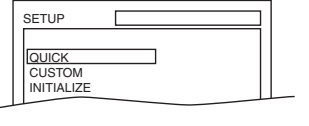

**2** Select the desired item.

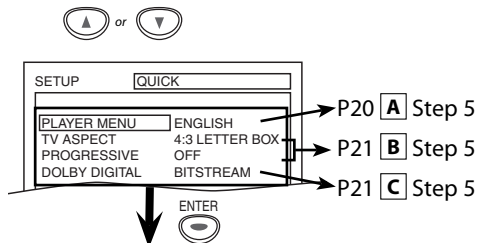

• Refer to the sections "PLAYER MENU", "TV ASPECT", "PROGRESSIVE" or "DOLBY DIGITAL" section on page 20 or 21.

## CUSTOM Menu

You can change the settings of the unit.

• **QUICK** on pages 20-21 indicates DVD setting menus also accessible from "QUICK" menu.

**1** Press [SETUP] in the stop mode.

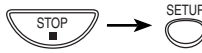

SETUP menu

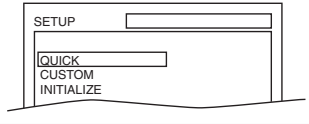

**2** Select "CUSTOM".

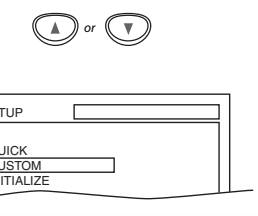

**3** Select the desired item.

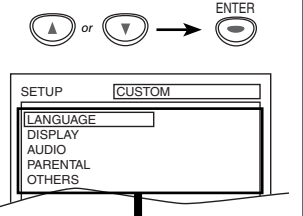

LANGUAGE menu

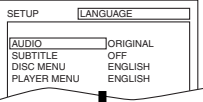

page 20 **A**

DISPLAY menu

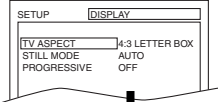

page 21 **B**

AUDIO menu

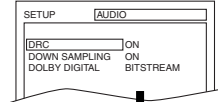

page 21 **C**

PARENTAL menu

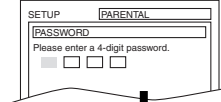

page 22 **D**

OTHERS menu

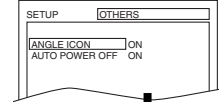

page 22 **E**

## **A** LANGUAGE Setting

Follow steps 1 to 3 in the "CUSTOM Menu" section above.

**4** Select the desired item.

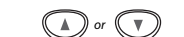

LANGUAGE menu

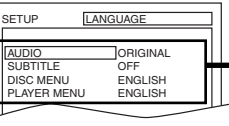

### Note:

• In "QUICK" menu, "PLAYER MENU", "TV ASPECT", "PROGRESSIVE" or "DOLBY DIGITAL" are available. "QUICK" menu consists of the setting menu frequently used, and they are accompanied with **QUICK**. You can make all settings in "CUSTOM" menu.

**5** Select the desired language.

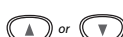

**AUDIO: \*1 \*2**  
(Default: ORIGINAL)  
Sets the audio language.

**SUBTITLE: \*1 \*2**  
(Default: OFF)  
Sets the subtitle language.

**DISC MENU: \*1**  
(Default: ENGLISH)  
Sets the language for DVD menu.

**PLAYER MENU: QUICK**  
(Default: ENGLISH)  
Sets the language for the on-screen display.

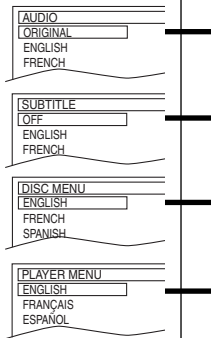

**6** To exit the menu



### Note:

**\*1**

- Language options are not available with some discs.
- If "OTHER" is selected on "AUDIO", "SUBTITLE" or "DISC MENU" screen, press 4-digit number to enter the code for the desired language. Refer to the "Language Code List" on page 24.
- Only the languages supported by the disc can be selected.

**\*2**

- "LANGUAGE" setting for "AUDIO" and "SUBTITLE" are not available with some discs. Then use **[AUDIO=1]** and **[SUBTITLE]**. Refer to page 19.



## B DISPLAY Setting

You can change the display functions. Follow steps 1 to 3 in the "CUSTOM Menu" section on page 20.

**4** Select the desired item.

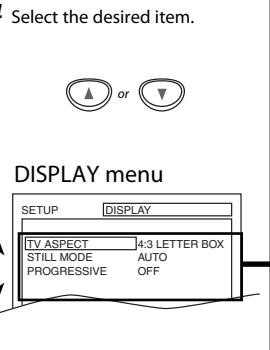

**Note:**  
**PROGRESSIVE:**

- You can set "PROGRESSIVE" to "OFF" in "DISPLAY" menu or press and hold [PLAY] on this unit for more than 5 seconds during playback until the PROGRESSIVE SCAN indicator on this unit turns off.
- When "PROGRESSIVE" is "ON", video signals from the unit's VIDEO OUT and S-VIDEO OUT jacks will be distorted or not be output at all.

**Note:**

- In "QUICK" menu, "PLAYER MENU", "TV ASPECT", "PROGRESSIVE" or "DOLBY DIGITAL" are available. "QUICK" menu consists of the setting menu frequently used, and they are accompanied with **QUICK**. You can make all settings in "CUSTOM" menu.

**5**

**TV ASPECT: QUICK (Default: 4:3 LETTER BOX)**  
See note on the right.

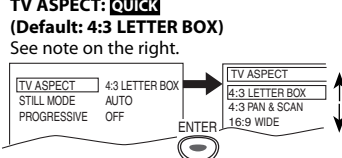

Select the desired setting.

**STILL MODE: (Default: AUTO)**  
See note on the right.

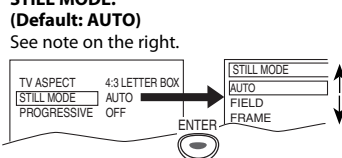

Select the desired setting.

**PROGRESSIVE: QUICK (Default: OFF)**  
See note on the left.

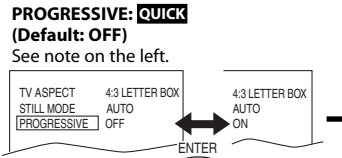

If there is no picture or you do not press any buttons for 15 seconds, "PROGRESSIVE" will switch to "OFF" and it will exit the "SETUP" menu.

**6** To exit "TV ASPECT" or "STILL MODE" menu

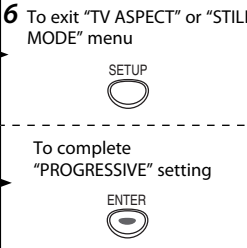

To complete "PROGRESSIVE" setting

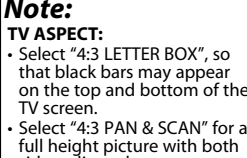

**Note:**  
**TV ASPECT:**

- Select "4:3 LETTER BOX", so that black bars may appear on the top and bottom of the TV screen.
- Select "4:3 PAN & SCAN" for a full height picture with both sides adjusted.
- Select "16:9 WIDE" if a wide-screen TV is connected to this unit.

**STILL MODE:**

- Select "AUTO" usually.
- If you select "AUTO", it automatically selects the best resolution setting ("FRAME" or "FIELD") based on the data characteristics of the pictures. (default)
- If you select "FIELD", the picture in the still mode will be stabilized.
- If you select "FRAME", the picture in the still mode will be highly defined.
- An individual picture on the TV screen is called a "frame", which consists of two separate images called as "field".
- Some pictures may be blurred if you select "AUTO" in the still mode due to their data characteristics.

## C AUDIO Setting

Choose the appropriate audio setting for your device. It only affects during the playback of DVD discs. Follow steps 1 to 3 in the "CUSTOM Menu" section on page 20.

**4** Select the desired item.

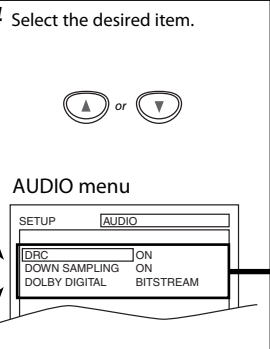

**Note:**

- In "QUICK" menu, "PLAYER MENU", "TV ASPECT", "PROGRESSIVE" or "DOLBY DIGITAL" are available. "QUICK" menu consists of the setting menu frequently used, and they are accompanied with **QUICK**. You can make all settings in "CUSTOM" menu.

**5**

**DRC (Dynamic Range Control): (Default: ON)**  
Set to "ON" to compress the range between soft and loud sounds.

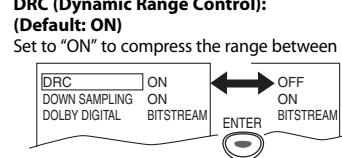

**DOWN SAMPLING: (Default: ON)**  
Set to "ON" when outputting in 48kHz.  
Set to "OFF" when outputting the original sound.

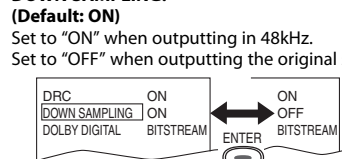

**DOLBY DIGITAL: QUICK (Default: BITSTREAM)**  
Set to "BITSTREAM" when the unit is connected to a Dolby Digital decoder.

- BITSTREAM: outputs Dolby Digital signals.
- PCM: converts the Dolby Digital into PCM (2 channel).

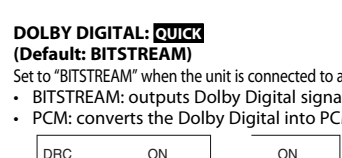

**6** To exit the menu

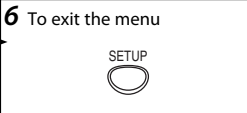

**Note:**  
**DRC:**

- This function is available only on the discs which are recorded in the Dolby Digital format.

**DOWN SAMPLING:**

- When playing back a 96kHz disc with the copyright protection, or when virtual surround is set to "1" or "2", the sound will be down sampled at 48kHz even if the "DOWN SAMPLING" is set to "OFF".
- This function is available only on digital outputting of a disc recorded in 96kHz.



## D PARENTAL Setting

This function prevents unit from playing material inappropriate for children.

### Parental Levels

Parental level allows you to set the rating levels of your DVD software. Playback will stop if the ratings exceed the levels you set. Follow steps 1 to 3 in the "CUSTOM Menu" section on page 20.

**4** Enter your desired 4-digit password (expect for 4737).

**PARENTAL menu**

SETUP PARENTAL

PASSWORD

Please enter a 4-digit password.

□ □ □ □

..... Or .....

If you have set a password already, enter the current 4-digit password.

SETUP PARENTAL

PASSWORD

Enter current password.

□ □ □ □

**5** Select "PARENTAL LEVEL".

**CONTROL LEVELS**

- ALL: all parental locks are canceled.
- Level 8: DVD software of any grades (adult/general/children) can be played back.
- Levels 7 to 2: only DVD software intended for general use and children can be played back.
- Level 1: only DVD software intended for children can be played back, with those intended for adult and general use prohibited.

**TIPS FOR LEVELS**

- 8 [ADULT]: DVD software of any grades (adult/general/children) can be played back.
- 7 [NC-17]: no one under 17 admitted
- 6 [R]: restricted; under 17 requires accompanying parent or adult guardian
- 5 [PGR]: parental guidance recommended
- 4 [PG13]: unsuitable for children under 13
- 3 [PG]: parental guidance suggested
- 2 [G]: general audience
- 1 [KID SAFE]: suitable for children

**Note:**

- Some DVD-video may not respond to "PARENTAL" setting. Make sure this function works with your DVD-video.

**6** Select the desired level.

**7** To exit the menu

### To Change the Password for Parental Controls

You can change your password for parental controls. Follow steps 1 to 3 in the "CUSTOM Menu" section on page 20.

**4** Enter current 4-digit password.

**PARENTAL menu**

SETUP PARENTAL

PASSWORD

Enter current password.

□ □ □ □

**5** Select "PASSWORD CHANGE".

**6** Enter your new 4-digit password (except for 4737).

**7** To exit the menu

**Note:**

- Record the password in case you forget it.
- If you forget the password, press [4], [7], [3], [7] at step 4, then enter your new password. Password will be cleared and parental levels will be set to "ALL".

## E OTHERS Setting

You can change the other functions. Follow steps 1 to 3 in the "CUSTOM Menu" section on page 20.

**4** Select the desired item.

**OTHERS menu**

SETUP OTHERS

ANGLE ICON ON

AUTO POWER OFF ON

**5**

**ANGLE ICON: (Default: ON)**  
Set to "ON" to display when multiple camera angles are available during DVD playback.

**AUTO POWER OFF: (Default: ON)**  
Set to "ON" to turn this unit off automatically after 30 minutes of no use.

**6** To exit the menu



## Reset to the Default Setting (Except for PARENTAL Setting)

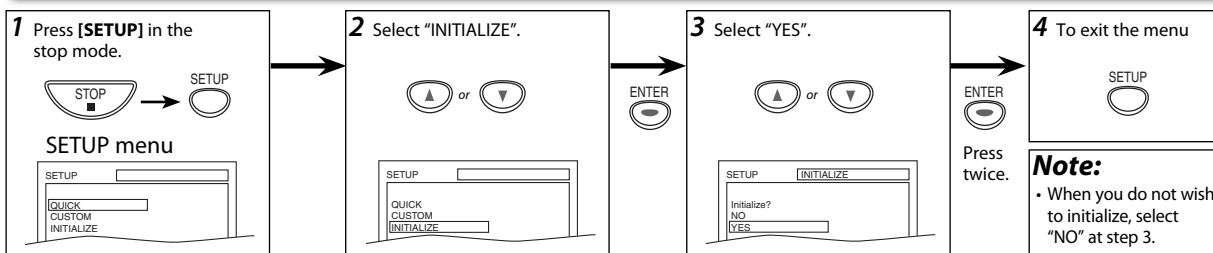

## INFORMATION

### Troubleshooting Guide

If this unit does not perform properly when operated as instructed in this manual. Refer to the following:

	Problem	Corrective action
DVD / VCR	No power.	<ul style="list-style-type: none"> <li>• Make sure the power plug is connected to an AC outlet.</li> <li>• Make sure the power is turned on.</li> </ul>
	This unit does not respond to the remote control.	<ul style="list-style-type: none"> <li>• Check if the power plug is connected to an AC outlet.</li> <li>• Check the batteries in the remote control.</li> <li>• Aim the remote control directly at the infrared sensor window. If necessary, remove all the obstacles between the sensor and the remote control.</li> <li>• You have to be within 23 feet (7m) of this unit.</li> <li>• Check if a cassette tape is in this unit.</li> <li>• Tune your radio to an empty AM station so that you hear a lot of static. Turn up the volume, then if you hear some signal sound from the radio in response to your pressing buttons on the remote control, the remote control is working.</li> <li>• Press and hold any button on remote control toward a digital camera. The remote control is working if you confirm infrared light through the digital camera.</li> </ul>
	Poor picture or noise.	<ul style="list-style-type: none"> <li>• Interference signal may be received. Change the position and direction of the unit.</li> </ul>
VCR	Cannot record a TV program.	<ul style="list-style-type: none"> <li>• This unit does not have a tuner to receive TV broadcasting.</li> <li>• You must connect this unit to TV with audio/video output jacks or an external tuner to record TV programs. Refer to "Recording &amp; One-touch Timer Recording (OTR)" on page 12 and "Satellite Link" on page 14.</li> </ul>
	Timer recording is impossible.	<ul style="list-style-type: none"> <li>• Make sure the timer program is set correctly.</li> <li>• Make sure [ ] indicator on this unit lights up. If not, press [T-SET].</li> <li>• Make sure the VCR clock is set correctly.</li> </ul>
	Cannot go into record mode.	<ul style="list-style-type: none"> <li>• Make sure the cassette tape has a record tab. If needed, cover the hole with adhesive tape.</li> <li>• Activate this unit in VCR mode. Press [VCR ] on the remote control so that the VCR OUTPUT light will illuminate.</li> </ul>
	Playback picture is partially noisy.	<ul style="list-style-type: none"> <li>• Adjust tracking control for a better picture by pressing [TRACKING ▼ / ▲] on the unit or [TRACKING ▲ / ▼] on the remote control.</li> </ul>
	Cannot view a picture but the audio is OK.	<ul style="list-style-type: none"> <li>• Head cleaning may be necessary. Refer to "Auto Head Cleaning".</li> <li>• Make sure the VCR is not in the VCR menu mode.</li> </ul>
	No or poor, playback picture.	<ul style="list-style-type: none"> <li>• Fine tune your TV.</li> </ul>
	Video or color fades in and out when making a copy of a cassette tape.	<ul style="list-style-type: none"> <li>• You cannot copy a copyrighted cassette tape.</li> </ul>
Cannot remove the cassette tape.	<ul style="list-style-type: none"> <li>• Check if this unit is in the VCR mode. If not, press [VCR ] on the remote control to switch the mode.</li> </ul>	
DVD	No picture.	<ul style="list-style-type: none"> <li>• Connect the video cable firmly.</li> <li>• Insert a correct video disc that can be played back on this unit.</li> <li>• Press [DVD ] on the remote control. Check if the DVD OUTPUT light will illuminate. Then try other DVD features.</li> <li>• Set "PROGRESSIVE" correctly in "DISPLAY" menu. Turn it on only if your TV has progressive scan and you are using the component video connections between the unit and the TV. Disable progressive scan for all other connections. Refer to page 6.</li> </ul>
	Disc cannot be played back.	<ul style="list-style-type: none"> <li>• Insert the disc.</li> <li>• Clean the disc.</li> <li>• Place the disc correctly with the label side up.</li> <li>• Cancel the parental lock or change the control levels.</li> <li>• Handle a disc with special care so that it does not have fingerprints, scratches, or dusts on its surface.</li> </ul>
	No sound.	<ul style="list-style-type: none"> <li>• Connect the audio cables firmly.</li> <li>• Turn on the power of the audio component.</li> <li>• Correct the audio output settings.</li> <li>• Correct the input settings on the audio component.</li> </ul>
	No DTS audio is output.	<ul style="list-style-type: none"> <li>• This unit does not support DTS audio.</li> <li>• This is not a malfunction.</li> </ul>
	Distorted picture.	<ul style="list-style-type: none"> <li>• Connect this unit directly to the TV.</li> <li>• There are some cases where pictures may be slightly distorted, and those are not a sign of a malfunction.</li> <li>• Although pictures may stop for a moment, this is not a malfunction. Refer to page 15.</li> <li>• Check if the progressive mode is set correctly according to your TV. Refer to pages 20-21.</li> </ul>
	Audio or subtitle language does not match the setting.	<ul style="list-style-type: none"> <li>• The selected language is not available for audio or subtitles on the DVD.</li> <li>• This is not a malfunction.</li> </ul>
	The camera angle cannot be changed.	<ul style="list-style-type: none"> <li>• The DVD does not contain sequences recorded from different camera angles.</li> <li>• This is not a malfunction.</li> </ul>
	Audio or subtitle language cannot be changed.	<ul style="list-style-type: none"> <li>• The DVD does not contain audio source or subtitles in the selected language.</li> <li>• This is not a malfunction.</li> </ul>
	"Q" appears on the TV screen, prohibiting an operation.	<ul style="list-style-type: none"> <li>• That operation is prohibited by this unit or the disc.</li> <li>• This is not a malfunction.</li> </ul>

- Some functions are not available in specific modes, but this is not a malfunction. Read the description in this manual for details on correct operations.
- Playback from a desired track and random playback are not available during programmed playback.
- Some functions are prohibited on some discs.



## Specifications

Video heads : 4-heads	Operating temperature : 41°F (5°C) to 104°F (40°C)	• Designs and specifications are subject to change without notice. • If there is a discrepancy between languages, the default language will be English.
Output signal format : NTSC color	Dimensions : W : 17 3/16" (435 mm) H : 3 3/4" (94 mm) D : 9 3/16" (233 mm)	
Power source : 120 V AC +/- 10%, 60 Hz +/- 0.5%	Weight : Approx 5.8 lbs (2.6 kg)	
Power consumption : 16 W (standby : 2.8 W)		

## Language Code List

Language	Code	Language	Code	Language	Code	Language	Code
Abkhazian	<b>A-B</b> 4748	French [FRE]	5264	Macedonian	5957	Siswat	6565
Afar	4747	Frisian	5271	Malagasy	5953	Slovak	6557
Afrikaans	4752	Galician	5358	Malay	5965	Slovenian [SLO]	6558
Albanian	6563	Georgian	5747	Malayalam	5958	Somali	6561
Amharic	4759	German [GER]	5051	Maltese	5966	Spanish [SPA]	5165
Arabic	4764	Greek [GRE]	5158	Maori	5955	Sundanese	6567
Armenian	5471	Greenlandic	5758	Marathi	5964	Swahili	6569
Assamese	4765	Guarani	5360	Moldavian	5961	Swedish [SWE]	6568
Aymara	4771	Gujarati	5367	Mongolian	5960		<b>T</b>
Azerbaijani	4772	Hausa	5447	Nauru	6047	Tagalog	6658
Bashkir	4847	Hebrew	5569	Nepali	6051	Tajik	6653
Basque	5167	Hindi	5455	Norwegian [NOR]	6061	Tamil	6647
Bengali; Bangla	4860	Hungarian [HUN]	5467		<b>O-R</b>	Tatar	6666
Bhutani	5072			Occitan	6149	Telugu	6651
Bihari	4854	Icelandic [ICE]	<b>I-K</b> 5565	Oriya	6164	Thai	6654
Bislama	4855	Indonesian	5560	Oromo(Afan)	6159	Tibetan	4861
Breton	4864	Interlingua	5547	Panjabi	6247	Tigrinya	6655
Bulgarian [BUL]	4853	Interlingue	5551	Pashto; Pushto	6265	Tonga	6661
Burmese	5971	Inupiak	5557	Persian	5247	Tsonga	6665
Byelorussian	4851	Irish [IRI]	5347	Polish [POL]	6258	Turkish [TUR]	6664
		Italian [ITA]	5566	Portuguese [POR]	6266	Turkmen	6657
		Japanese [JPN]	5647	Quechua	6367	Twí	6669
		Javanese	5669	Rhaeto-Romance	6459		<b>U-Z</b>
		Kannada	5760	Romanian [RUM]	6461	Ukrainian	6757
		Kashmiri	5765	Russian [RUS]	6467	Urdu	6764
		Kazakh	5757		<b>S</b>	Uzbek	6772
		Kinyarwanda	6469	Samoan	6559	Vietnamese	6855
		Kirghiz	5771	Sangho	6553	Volapuk	6861
		Kirundi	6460	Sanskrit	6547	Welsh	4971
		Korean [KOR]	5761	Scots Gaelic	5350	Wolof	6961
		Kurdish	5767	Serbian	6564	Xhosa	7054
				Serbo-Croatian	6554	Yiddish	6555
		Laothian	<b>L-N</b> 5861	Sesotho	6566	Yoruba	7161
		Latin	5847	Setswana	6660	Zulu	7267
		Latvian; Lettish	5868	Shona	6560		
		Lingala	5860	Sindhi	6550		
		Lithuanian	5866	Singhalese	6555		

If you choose a Language that has a 3-letter language code, the code will be displayed every time you change the audio or subtitle language setting on page 19. If you choose any other languages, '-' will be displayed instead. (3-letter language code is written in bracket.)

## SYLVANIA LIMITED WARRANTY

FUNAI CORP. will repair this product, free of charge in the USA in the event of defect in materials or workmanship as follows:

### DURATION:

**PARTS:** FUNAI CORP. will provide parts to replace defective parts without charge for one (1) year from the date of original retail purchase. Certain parts are excluded from this warranty.

**LABOR:** FUNAI CORP. will provide the labor without charge for a period of ninety (90) days from the date of original retail purchase.

### LIMITS AND EXCLUSIONS:

This warranty is extended only to the original retail purchaser. A purchase receipt or other proof of original retail purchase will be required together with the product to obtain service under this warranty.

This warranty shall not be extended to any other person or transferee.

This warranty is void and of no effect if any serial numbers on the product are altered, replaced, defaced, missing or if service was attempted by an unauthorized service center. This limited warranty does not apply to any product not purchased and used in the United States.

This product is produced for home use and this warranty only covers failures due to defects in material or workmanship which occurs during normal use. It does not cover damage which occurs in shipment, or failures which are caused by repairs, alterations or product not supplied by FUNAI CORP., or damage which results from accident, misuse, abuse, mishandling, misapplication, alteration, faulty installation, improper maintenance, commercial use such as hotel, rental or office use of this product or damage which results from fire, flood, lightning or other acts of God.

THIS WARRANTY DOES NOT COVER PACKING MATERIALS, ANY ACCESSORIES (EXCEPT REMOTE CONTROL), ANY COSMETIC PARTS, COMPLETE ASSEMBLY PARTS, DEMO OR FLOOR MODELS.

FUNAI CORP. AND ITS REPRESENTATIVES OR AGENTS SHALL IN NO EVENT BE LIABLE FOR ANY GENERAL, INDIRECT OR CONSEQUENTIAL DAMAGES ARISING OUT OF OR OCCASIONED BY THE USE OF OR THE INABILITY TO USE THIS PRODUCT. THIS WARRANTY IS MADE IN LIEU OF ALL OTHER WARRANTIES, EXPRESS OR IMPLIED, AND OF ALL OTHER LIABILITIES ON THE PART OF FUNAI,

ALL OTHER WARRANTIES INCLUDING THE WARRANTY OF MERCHANTABILITY, AND FITNESS FOR A PARTICULAR PURPOSE, ARE HEREBY DISCLAIMED BY FUNAI AND ITS REPRESENTATIVES IN THE UNITED STATES. ALL WARRANTY INSPECTIONS AND REPAIRS MUST BE PERFORMED BY AN AUTHORIZED SERVICE CENTER. THIS WARRANTY IS VALID WHEN THE UNIT IS CARRIED-IN TO AN AUTHORIZED SERVICE CENTER.

### IMPORTANT:

THIS LIMITED WARRANTY GIVES YOU SPECIFIC LEGAL RIGHTS. YOU MAY HAVE OTHER RIGHTS THAT VARY FROM STATE TO STATE. IF, AT ANY TIME DURING THE WARRANTY PERIOD, YOU ARE UNABLE TO OBTAIN SATISFACTION WITH THE REPAIR OF THIS PRODUCT, PLEASE CONTACT FUNAI CORP.

### ATTENTION:

FUNAI CORP. RESERVES THE RIGHT TO MODIFY ANY DESIGN OF THIS PRODUCT WITHOUT PRIOR NOTICE.

### WARRANTY STATEMENT REGARDING NON AUTHORIZED REPAIRS:

To obtain warranty service, you must take the product, or deliver the product freight prepaid, in either its original packaging or packaging affording an equal degree of protection, to any AUTHORIZED SERVICE CENTER. FUNAI CORP. will not reimburse you for any service done by unauthorized service providers without prior written approval.

To locate your nearest AUTHORIZED SERVICE CENTER or for general service inquiries, please contact us at:

### FUNAI SERVICE CORPORATION

Tel: 1-800-968-3429

<http://www.sylvaniaconsumerelectronics.com>

2200 Spiegel Drive, Groveport, OH 43125



### 1 Conexiones

Consulte la "Basic TV Connection" en la página delantera antes de utilizar esta unidad.

### 2 Instalación de las pilas del control remoto

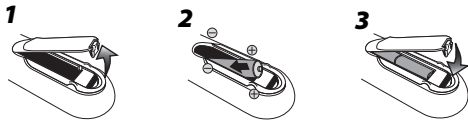

### 3 Conmutación VCR/DVD

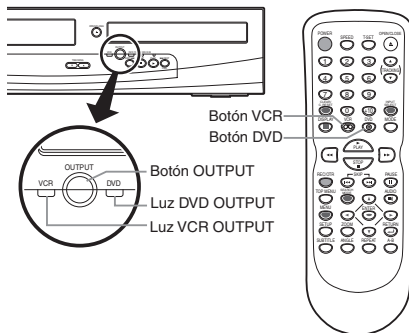

#### MODO VCR

Pulse [VCR] en el control remoto. (Compruebe que está encendida la luz VCR OUTPUT.)

#### MODO DVD

Pulse [DVD] en el control remoto. (Compruebe que está encendida la luz DVD OUTPUT.)

### 4 Activación de la unidad por primera vez



1 Asegúrese de que la entrada de su TV esté en VIDEO. (El nombre puede cambiar según el fabricante del TV. Consulte el manual de su TV para conocer más detalles.)

2 Seleccione su idioma la primera vez que encienda esta unidad. A continuación, pulse [▶] para ir al siguiente paso.

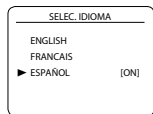

3 Cuando "AJUSTE DE RELOJ" aparezca, avance al segundo paso de "Ajuste del reloj" en esta página.



### 5 Ajuste del reloj



1 Pulse [SETUP] para seleccionar "AJUSTE DE RELOJ". A continuación, pulse [▶] para ir al siguiente paso.



• Si no se ha ajustado el reloj, aparece la pantalla "AJUSTE DE RELOJ" cuando pulse [SETUP]. En este caso, vaya al paso 2.

2 Seleccione el mes actual. A continuación, pulse [▶] para ir al siguiente paso.



3 Seleccione el día actual. A continuación, pulse [▶] para ir al siguiente paso.



4 Seleccione el año actual. A continuación, pulse [▶] para ir al siguiente paso.



5 Seleccione la hora actual. A continuación, pulse [▶] para ir al siguiente paso.

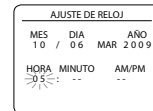

6 Seleccione los minutos actuales. A continuación, pulse [▶] para ir al siguiente paso.

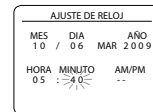

7 Seleccione "AM" o "PM".



8 Presione [SETUP] para salir del menú "AJUSTE DE RELOJ".



corte aquí





Español

## 6 Reproducción de la grabadora de vídeo

**Antes:**

Encienda el televisor.







<p><b>1</b> Inserte un casete de vídeo en esta unidad.</p> 	<p><b>2</b> Para empezar la reproducción</p> 
<p><b>3</b> Para parar la reproducción</p> 	<p><b>4</b> Para expulsar</p> 

## 7 Reproducción de DVD/CD

**Antes:**

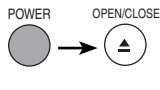
Encienda el televisor, amplificador y otros equipos que puedan estar conectados a esta unidad. Asegúrese que el televisor y el sintonizador de audio están en el canal correcto.



<p><b>1</b></p> 	<p><b>2</b> Ponga un disco con la etiqueta hacia arriba.</p> 
<p><b>3</b> Para empezar la reproducción</p> 	<p><b>4</b> Para parar la reproducción</p> 

## 8 Control remoto

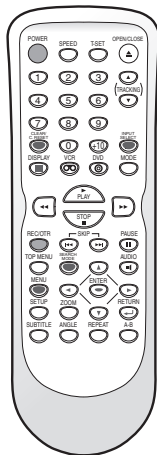

Botón (Orden alfabético)	Modo DVD			Modo de grabadora de vídeo
	DVD	CD	MP3	VHS
1 2 3 4 5 6 7 8 9 0	• Para seleccionar directamente el capítulo o el título.	• Para seleccionar directamente la canción.		—
◀ ▶	• Para buscar en avance/retroceso en un disco. • Para empezar la reproducción en avance/retroceso lento durante el modo de pausa.	• Para buscar en avance/retroceso en un disco.		• Para el avance/retroceso de una cinta. • Para empezar la reproducción en avance lento durante el modo de pausa.
A-B	• Para repetir entre los puntos A y B elegidos.	• Para repetir entre los puntos A y B elegidos. (CD)		—
ANGLE	• Para seleccionar los ángulos de la cámara en un disco.	—		—
AUDIO	• Para seleccionar el idioma de audio en un disco.	• Para seleccionar "ESTÉREO", "L-ch" o "R-ch". (CD)		—
CLEAR/RESET	• Para borrar los marcadores. • Para borrar los números mal entrados. • Para borrar el punto para la repetición A-B.	• Para borrar los marcadores. (CD) • Para eliminar el N° de estado en la entrada de programa. • Para borrar los números mal entrados. • Para borrar el punto para la repetición A-B. (CD)		• Para salir del menú de la grabadora de vídeo. • Para reponer el contador de cinta.
DISPLAY	• Para indicar el modo de disco actual.	• Para indicar el modo de disco actual.		• Para indicar la hora actual, contador de cinta y L1 o L2.
DVD	• Para seleccionar el modo de salida de DVD. • Para activar el modo DVD.	• Para seleccionar el modo de salida de DVD. • Para activar el mando a distancia en el modo DVD.		—
ENTER	• Para mover el cursor y determinar su posición.	• Para mover el cursor y determinar su posición.		• Para seleccionar un ítem en el menú de la grabadora de vídeo. • Para avanzar al siguiente menú de la grabadora de vídeo. • Para volver un paso durante el ajuste del reloj y temporizador.
INPUT SELECT	—	—		• Para seleccionar L1 o L2.
MENU	• Para llamar el menú en un disco.	• Para llamar la lista de archivo. (MP3)		—
MODE	• Para activar/desactivar el nivel del negro. • Para activar/desactivar el ambiente virtual.	• Para disponer el orden de reproducción o la reproducción aleatoria. • Para activar/desactivar el envolvente virtual.		—
OPEN/CLOSE	• Para abrir o cerrar la bandeja del disco.	• Para abrir o cerrar la bandeja del disco.		• Para expulsar la cinta de casete del compartimiento del casete.
PAUSE	• Para hacer una pausa de reproducción del disco. • Para avanzar la reproducción un cuadro a la vez.	• Para hacer una pausa en la reproducción del disco.		• Para hacer una pausa de la reproducción o grabación de la cinta. • Para avanzar la reproducción un cuadro a la vez.
PLAY	• Para empezar la reproducción del disco.	• Para empezar la reproducción del disco.		• Para empezar la reproducción de la cinta.
POWER	• Para encender o para pasar la unidad al modo de espera. (Para apagar completamente la unidad, debe desconectar el cable de alimentación de CA.)	• Para encender o para pasar la unidad al modo de espera. (Para apagar completamente la unidad, debe desconectar el cable de alimentación de CA.)		• Para encender o para pasar la unidad al modo de espera. (Para apagar completamente la unidad, debe desconectar el cable de alimentación de CA.)
REC/OTR	—	—		• Para empezar una grabación o una grabación de un toque.
REPEAT	• Para reproducir repetidamente un capítulo o título.	• Para reproducir repetidamente una canción, grupo o disco. (MP3)		• Para activar/desactivar el modo de repetición.
RETURN	• Para volver a la operación previa en el menú.	• Para volver a la operación previa en el menú.		—
SEARCH MODE	• Para buscar un capítulo, título u hora. • Para colocar o buscar los marcadores.	• Para buscar una canción. • Para buscar el tiempo. (CD) • Para colocar o buscar los marcadores. (CD)		• Para llamar el menú de búsqueda de índice u hora.
SETUP	• Para llamar el menú de programación de DVD.	• Para llamar el menú de programación de DVD.		• Para llamar el menú de la grabadora de vídeo.
SKIP	• Para saltar capítulos o título.	• Para saltar canciones.		—
SPEED	—	—		• Para seleccionar la velocidad de grabación.
STOP	• Para parar la reproducción.	• Para parar la reproducción.		• Para parar la reproducción o grabación.
SUBTITLE	• Para seleccionar subtítulos en un disco.	—		—
TOP MENU	• Para llamar el menú superior en un disco.	• Para volver al archivo superior de la jerarquía más alta en el programa y en la lista de archivo. (MP3)		—
TRACKING	—	—		• Para ajustar manualmente el seguimiento durante la reproducción.
T-SET	—	—		• Para poner la grabadora de vídeo en el modo de espera para una grabación con temporizador.
VCR	—	—		• Para seleccionar el modo de salida de la grabadora de vídeo. • Para activar el modo de la grabadora de vídeo.
ZOOM	• Para ampliar parte de la imagen. (2x/4x)	—		—

cut here

# Quick Use Guide

## 1 Connections

Please refer to "Basic TV Connection" on the front page before you use this unit.

## 2 Installing the Batteries for the Remote Control

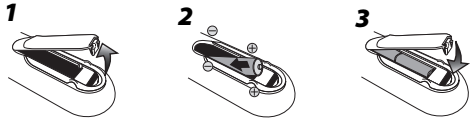

## 3 VCR/DVD Switching

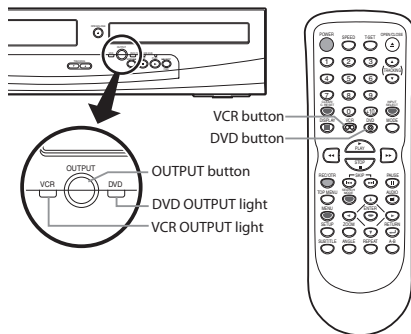

### VCR MODE

Press [VCR] on the remote control. (The VCR OUTPUT light illuminates.)

### DVD MODE

Press [DVD] on the remote control. (The DVD OUTPUT light illuminates.)

## 4 Turning on Unit for the First Time



1 Be sure your TV's input is set to VIDEO. (Name may vary with TV manufacturer. See your TV manual for details.)



2 Press [▲ / ▼] to select your on-screen language. Then press [▶] to continue.

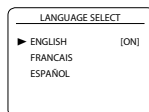
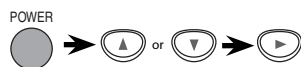

3 When "CLOCK SET" menu appears, go to step 2 in "Clock Setting" on this page.

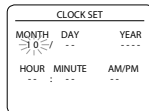

## 5 Clock Setting



1 Press [SETUP] and select "CLOCK SET". Then press [▶] to go to next step.

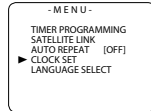

• If the clock is not set, "CLOCK SET" menu appears when you press [SETUP]. In this case, go to step 2.

2 Select the current month. Then press [▶] to go to next step.

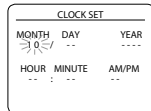

3 Select the current day. Then press [▶] to go to next step.

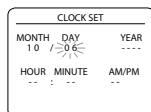

4 Select the current year. Then press [▶] to go to next step.

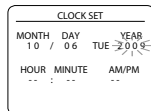

5 Select the current hour. Then press [▶] to go to next step.

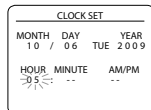

6 Select the current minute. Then press [▶] to go to next step.

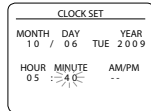

7 Select "AM" or "PM".

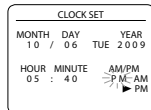
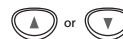

8 Press [SETUP] to exit the "CLOCK SET" menu.



corte aqui

# Quick Use Guide

## 6 VCR Playback

**Before:**

Turn on the TV.



<p><b>1</b> Insert a cassette tape into this unit.</p>	<p><b>2</b> To start playback</p>
<p><b>3</b> To stop playback</p>	<p><b>4</b> To eject the cassette tape</p>

## 7 DVD/CD Playback

**Before:**

Turn on the TV, amplifier and any other components which are connected to this unit. Make sure the TV and audio receiver are set to the correct channel.



<p><b>1</b></p>	<p><b>2</b> Insert a disc with label facing up.</p>
<p><b>3</b> To start playback</p>	<p><b>4</b> To stop playback</p>

## 8 Remote Control

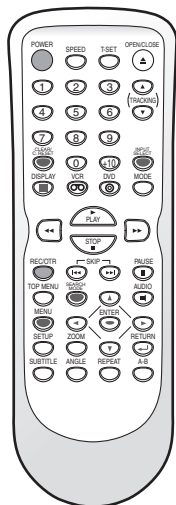

Button (Alphabetical order)	Media	DVD mode		VCR mode
		DVD	CD MP3	VHS
1 2 3 4 5 6 7 8 9 0		• To select chapter or title directly.	• To select track or file directly.	—
◀ ▶		• To search forward/backward through a disc. • To begin slow forward/reverse playback in the pause mode.	• To search forward/backward through a disc.	• To forward/backward a tape. • To begin slow forward playback in the pause mode.
A-B		• To repeat between your chosen point of A and B.	• To repeat between your chosen point of A and B. (CD)	—
ANGLE		• To select camera angles on a disc.	—	—
AUDIO		• To select audio languages on a disc.	• To select "STEREO", "L-ch" or "R-ch". (CD)	—
CLEAR/ C-RESET		• To clear the markers. • To clear numbers entered incorrectly. • To cancel the point for A-B repeat.	• To clear the markers. (CD) • To remove status number in program input. • To clear numbers entered incorrectly. • To cancel the point for A-B repeat. (CD)	• To exit the VCR menu. • To reset the tape counter.
DISPLAY		• To display the current disc mode.	• To display the current disc mode.	• To display the current time, tape counter, and L1 or L2.
DVD		• To select DVD output mode. • To activate DVD mode.	• To select the DVD output mode. • To activate DVD mode.	—
ENTER		• To move the cursor and determine its position.	• To move the cursor and determine its position.	• To select an item on the VCR menu. • To advance to the next VCR menu. • To go back one step during clock and timer programming.
INPUT SELECT		—	—	• To select input L1 or L2.
MENU		• To call up the disc menu on a disc.	• To call up the file list. (MP3)	—
MODE		• To set black level on/off. • To set virtual surround on/off.	• To arrange the playing order or play randomly. • To set virtual surround on/off.	—
OPEN/CLOSE		• To open or close the disc tray.	• To open or close the disc tray.	• To eject the cassette tape from the cassette compartment.
PAUSE		• To pause disc playback. • To advance playback one frame at a time.	• To pause disc playback.	• To pause tape playback or recording. • To advance playback one frame at a time.
▶ PLAY		• To begin disc playback.	• To begin disc playback.	• To begin tape playback.
POWER		• To turn the unit on or to turn the unit into the standby mode. (To completely turn off the unit, you must unplug the AC power cord.)	• To turn the unit on or to turn the unit into the standby mode. (To completely turn off the unit, you must unplug the AC power cord.)	• To turn the unit on or to turn the unit into the standby mode. (To completely turn off the unit, you must unplug the AC power cord.)
REC/OTR		—	—	• To start recording or one-touch timer recording.
REPEAT		• To play back a chapter or title repeatedly.	• To play back a track or disc repeatedly. (CD) • To play back a file, folder or disc repeatedly. (MP3)	• To select the repeat mode on/off.
RETURN		• To return to the previous operation in menu.	• To return to the previous operation in menu.	—
SEARCH MODE		• To search chapter, title or time. • To set or search the markers.	• To search track or file. • To search time. (CD) • To set or search the markers. (CD)	• To call up the index or time search menu.
SETUP		• To call up the DVD menu.	• To call up the DVD menu.	• To call up the VCR menu.
SKIP		• To skip chapters or titles.	• To skip tracks or files.	—
SPEED		—	—	• To select the recording speed.
STOP		• To stop playback.	• To stop playback.	• To stop playback or recording.
SUBTITLE		• To select subtitles on a disc.	—	—
TOP MENU		• To call up the top menu on a disc.	• To return to the top file of the highest hierarchy in the program and file list. (MP3)	—
TRACKING		—	—	• To adjust the tracking manually during playback.
T-SET		—	—	• To put the VCR into standby mode for a timer recording.
VCR		—	—	• To select the VCR output mode. • To activate VCR mode.
ZOOM		• To magnify part of a picture. (2x/4x)	—	—

E8E0AUD  
1VMN28434 ★★★★★  
Printed in China



\* 1 V M N 2 8 4 3 4 \*

cut here